

E-PRTR and LCP Integrated data reporting

Manual for reporters

Version 1.2 – 15/01/2020



Cover design: EEA

Cover photo: Jorge Franganillo, Creative Commons Attribution 2.0 Generic (<https://goo.gl/rqHYk6>)

Layout: EEA

Acknowledgments

This manual for reporters was prepared by the [European Environment Agency](#) (EEA) in cooperation with the [European Topic Centre for Air Pollution, Transport, Noise and Industrial Pollution](#) (ETC/ATNI).

Should you have any need of clarification, please contact the EEA Industrial Pollution team (EEA) at industrial.emissions@eea.europa.eu.

Version control

Version ID	Description	Date
0.1	Internal draft for EEA	29/09/2017
0.2	Internal draft with integration of EEA comments	24/12/2017
0.3	External draft for consultation with Eionet focus group	06/02/2018
1.0	Final version	26/04/2018
1.1	Minor updates to Manual	01/05/2019
1.2	Updated guidance on reporting multiple fuelInput values under "OtherSolidFuel" and "OtherGaseousFuel" for LCPs (see section 3.3.3)	15/01/2020

Contents

Acknowledgments	2
Version control	2
Contents	3
1 Introduction	5
1.1 Purpose of this document	5
1.2 Structure of the document	6
1.3 The legal basis and relation to the EU Registry	6
1.4 Incorporating historical data	7
2 Understanding the E-PRTR-LCP Thematic Data flow	8
2.1 Scope definition and linking mechanism to the EU Registry	8
2.2 Key concepts.....	9
2.2.1 Numbers and precision	9
2.2.2 Confidentiality.....	10
2.2.3 Common stack principle for combustion plants.....	10
2.2.4 Code lists	13
2.3 Reporting on Large Point Sources under the Convention on Long-range Transboundary Air Pollution (CLRTAP) and National Emissions Ceiling Directive (NECD)	14
2.4 Deadlines for reporting	15
3 Understanding the data model	17
3.1 Basic Terminology.....	17
3.1.1 Multiplicity	18
3.2 Structure of the E-PRTR-LCP Thematic Data Model.....	18
3.3 Content of the E-PRTR-LCP Thematic Data Model.....	20
3.3.1 Report Data.....	22
3.3.2 ProductionInstallationPartReport	23
3.3.3 EnergyInput	27
3.3.4 EmissionsToAir.....	30

3.3.5	ProductionFacilityReport	31
3.3.6	OffSiteWasteTransfer	33
3.3.7	OffSitePollutantTransfer.....	35
3.3.8	PollutantRelease	37
4	Preparing country reports: use of the IT tools.....	39
4.1	Reporting data to the CDR: overall workflow	39
4.2	User accounts and permissions.....	39
4.3	Reporting routes.....	39
4.3.1	Using the XML Route: Preparation of a compliant XML file.....	40
4.3.2	Reporting using the Ms Access route: the template and the conversion service....	41
4.4	Login, creation of envelopes and upload of reports	41
4.5	Quality Assurance: validating your report	41
4.5.1	Scope and logic of the automated quality assurance.....	41
4.5.2	Validation feedback provided at CDR	41
4.6	Official submission of the report	42
4.7	Processes that take place after the submission.....	43
	Annex 1 – Internationally approved measuring methods.....	44
	Annex 2 – Indicative list of pollutants per E-PRTR activity	45
	Annex 3 – Examples of reporting	49
	Annex 4 – Glossary of Terms	54
	Annex 5 – Mapping between previous data structures and new structure	55

1 Introduction

1.1 Purpose of this document

This document aims to provide detailed guidance on the practicalities and processes for reporting to the E-PRTR+LCP Thematic Data Flow, a European-wide database maintained and published by the European Environment Agency (EEA) on behalf of the European Commission. In this context, a user is assumed to be a representative of an EU Member State or other reporting country who is submitting relevant country-level Thematic data.

This Manual for Reporters is intended to support reporting countries in providing high quality reports in an efficient manner and to fully understand the E-PRTR+LCP Thematic data structure and the required processes before, during and following submission. Specifically, this document covers:

- the legal basis and background of E-PRTR+LCP reporting.
- the fundamental structure of and technical requirements for a submission.
- the practicalities involved in reporting to the Central Data Repository (CDR) of EEA's Reportnet, and
- considerations for handling of change and ensuring coherent reporting over time.

A key goal of this document is to ensure a common understanding among EU-level organisations and data providers (i.e., operators and competent authorities). This document should further be of assistance to both thematic and IT experts.

This Manual for Reporters intends to be a stand-alone document that contains all necessary information for reporting to the E-PRTR+LCP Thematic Data Flow. There are however other documents that may offer additional detail on certain aspects, namely the associated E-PRTR and LCP Data Model Documentation and the QA/QC Logic Manual.

The Data Model Documentation more specifically addresses the development of the data structure for submissions, while the QA/QC logic provides the basis for the complex quality checks that are undertaken during the submission process. Users are encouraged to read the full documentation available to them for a complete understanding.

In addition to developing an understanding of the E-PRTR+LCP Thematic Data Flow, it is crucial to understand the context of this reporting relative to that of the EU Registry on Industrial Sites (hereafter the EU Registry). Both sets of reporting are designed to work in conjunction and therefore several aspects of the EU Registry have relevance to the content and structure of the E-PRTR+LCP Thematic Data Flow. Users are therefore encouraged to read the materials available¹ for the EU Registry before approaching this manual and other associated materials.

¹ EU Registry Data Model Documentation, QAQC Logic and Manual for Reporters can be found here: http://cdrtest.eionet.europa.eu/help/ied_registry

1.2 Structure of the document

This Manual for Reporters is structured as follows:

- **Introduction:** to establish the legal background and context of the E-PRTR-LCP Thematic Data Flow.
- **Understanding the E-PRTR-LCP Thematic Data Flow:** Provides the necessary information regarding the scope and structure of reporting.
- **Understanding the data model:** Details systematically, each attribute within the data model structure, which in turn forms the fundamental structure of a submission.
- **Preparing country reports:** use of IT tools: Details the IT resources available to reporting countries to make a submission, in addition to the reporting procedure in the Central Data Repository (CDR).

Such a structure is intended to build understanding as the user progresses through the necessary steps to finalise a submission.

1.3 The legal basis and relation to the EU Registry

The basis for the reporting of the thematic data captured within the E-PRTR+LCP Thematic Data Flow, originates in two fundamental legal instruments:

- the European Pollutant Release and Transfer Regulation 2006 (EC 166/2006) (hereafter referred to as the E-PRTR Regulation) – The Regulation solidifying the European Community's signatory to the Kiev Protocol of the Aarhus Convention.
- The Industrial Emissions Directive 2010/75/EU (IED) – Which consolidates several previous pieces of industrial legislation into one regulatory framework.

Both legal instruments mandate the reporting of data from Member States to the European Commission. Such reporting can be broadly split into two streams, one specifically for identification and administrative information, and one which concerns all thematic data, such as emissions or movements of specific wastes.

Previously the data mandated by both these instruments has been reported electronically by Member States, and voluntarily by a range of other countries. The data flows developed for both sets of reporting are generally considered as not fit for purpose. Such reporting also creates potential for duplication of data, via the compartmentalised nature of the respective data flows.

The European Commission and the EEA have therefore initiated a streamlining process which seeks to develop data flows which regard the type of data reported as opposed to the reporting obligation. The European Commission and the EEA therefore seek to:

- Establish an INSPIRE-compliant reference dataset, which centralises the identification and administrative details of all regulated entities with industrial activities. This dataflow is referred to as the EU Registry on Industrial Sites.
- The integration of thematic reporting from facilities subject to the E-PRTR Regulation and from large combustion plants (LCPs) under the scope of Chapter III of the IED in a unified data flow will allow streamlining and offer immediate validation to ensure the data reported is coherent and consistent.

It is this latter objective which forms the basis of this documentation. Both objectives, however, need to have linkages and it is intended that, despite the fact separate data flows will be established, a common linking

mechanism will enable the integration of the data reported under both the EU Registry and the E-PRTR+LCP Thematic Data Flow in a coherent manner to create a range of public data products. This intention is reflected in Figure 1 which details the intended outcomes of the streamlining process:

Figure 1 - Planned data flows for reporting and handling administrative and thematic data on industrial entities

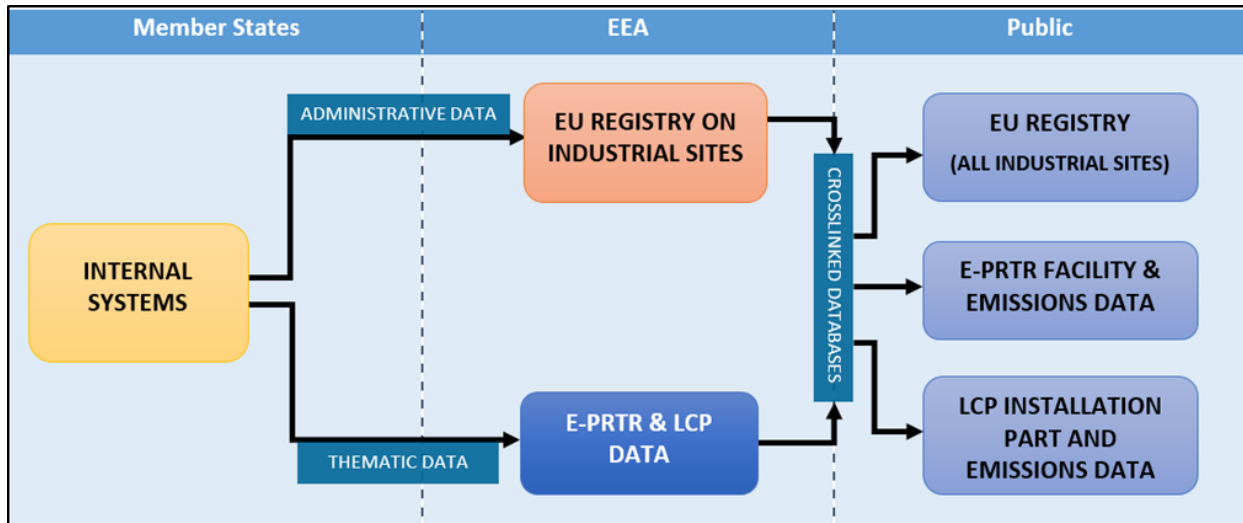

The European Commission is currently developing a new implementing decision that will ensure that a clear legal basis is established for the EU Registry and a formal reference to both the E-PRTR Regulation and the IED is established. The reporting of data under the E-PRTR-LCP Thematic Data Flow, however, can be considered as a continuation of the legal requirements specified in Article 72 of the IED and Annex III of the E-PRTR Regulation.

1.4 Incorporating historical data

To ensure continuity, the EEA will investigate the most appropriate option for transfer of the historical data reported to the pre-existing mechanisms, E-PRTR and LCP inventories. This transfer will require significant work to map identifiers from previous E PRTR and LCP submissions to the ones generated for use within E-PRTR-LCP Thematic Reporting and the EU Registry. Reporting countries will be engaged during the process of transferring the historical data to provide unique Inspire-compliant identifiers for all entities previously reported to the E-PRTR and LCP inventories.

2 Understanding the E-PRTR-LCP Thematic Data flow

2.1 Scope definition and linking mechanism to the EU Registry

The E-PRTR+LCP Thematic Data Flow consolidates the thematic data for LCPs and E-PRTR Facilities into one data flow. The scope definition therefore pertains to the reporting scope of both LCPs and E-PRTR facilities in the IED and E-PRTR Regulation respectively.

For E-PRTR facilities the reporting of release data and data pertaining to off-site transfer for wastewater treatment is only mandated if the pollutant thresholds in Annex II of the E-PRTR Regulation have been exceeded. Similarly, data for the off-site transfer of waste is only anticipated if the comparative thresholds in Article 5 of the E-PRTR Regulation is exceeded. The implication of the use of these thresholds is that if the respective threshold has not been exceeded, reporting for that aspect is not anticipated. Equally if the facility exceeds none of the respective thresholds, a user does not need to populate a thematic submission for that specific facility. The user may, however, still choose to supply some of the optional data pertaining to aspects such as production volumes, number of employees, and number of operating hours.

For LCPs, the reporting scope operates differently in the fact that no thresholds apply, except for the threshold defining an LCP, consisting of a combustion plant of 50MW (thermal input) capacity or more. Regarding aspects such as emissions or fuel input, no thresholds apply and therefore data is anticipated to be reported regardless of the size of the emissions, or regardless of the fact no emissions for a specific pollutant occurred. The same principles follow for fuel input information. This difference should be reflected in reporting. In addition, Article 29 of the IED specifies the ability to combine the reporting of combustion plants when gases are or could be (according to the judgement of the competent authority) emitted out of a common stack. This is known as the common stack principle. Under this scenario the IED states users should aggregate the two entities for the purpose of calculating the total rated thermal input, thus potentially entering the scope of the EU Registry. This same principle applies to the thematic data reported for LCPs, user may aggregate data for combustion plants, reporting them as a single LCP installation part. Further guidance on how this mechanism operates in terms of specific attributes can be found in Section 2.2.3. When considering the scope of reporting for LCPs, reporters should also take note of the exemptions noted in Article 28 of the IED.

It should be noted that the reporting to the E-PRTR+LCP Thematic data flow follows an initial submission to the EU Registry. Therefore, common identifiers, such as the inspireId, must reflect those facilities, and or InstallationParts (which represent LCPs in the EU Registry) already reported to the EU Registry. This consistency within the identifiers is fundamental to enabling the linking mechanism depicted in Figure 1 and therefore integral to the success of the streamlining process. The inspireIds and how they are intended to link through to the geographical hierarchy of the EU Registry is depicted in Figure 2.

Figure 2 - Thematic integration into the EU Registry

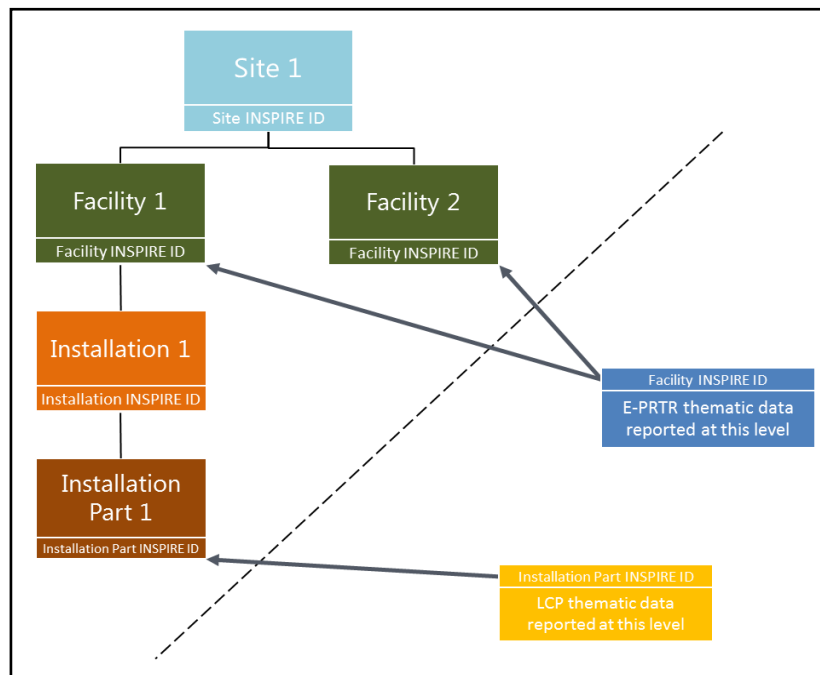

2.2 Key concepts

2.2.1 Numbers and precision

The various quantities and values reported throughout the E-PRTR+LCP Thematic Data Model should be populated according to three significant digits. This is a continuation of the value convention referred to in section 1.1.8 of the E-PRTR guidance document 2006². Such an approach accounts for the variation that is anticipated when reporting releases and emissions, with specific pollutants expected in large quantities contrasted with those that occur in comparatively small quantities. It should be noted that this convention applies only to those attributes which refer to 'doubles' in the E-PRTR+LCP Thematic Data Model and pertains to emissions, pollutant transfer or release data only (for example it does not apply to the reported number of operating hours as this is not emission or release data). 'Double' refers to a type number format defined by the IEEE (Institute of Electrical and Electronic Engineers), which enables the use of decimal number format and scientific notation (e.g. -1.23e56). Examples of reporting to three significant digits can be seen in Table 1. Attributes unrelated to emissions, releases or pollutant transfers, e.g. reported operating hours, transfers of waste or fuel input, do not need to be reported to three significant figures and should be reported to the most appropriate level of detail based on the judgement of the operator.

² Guidance Document for the implementation of the European PRTR, European Commission, (2006), <http://prtr.ec.europa.eu/#/downloadguidance>

Table 1 - Application of the 3 significant digit rule for emissions or releases

Original value	Value to be reported (applying 3 significant digit rule)
0.123467 kg/year	0.123 kg/year
2.1234 TNE/year	2.12 TNE/year
71,878 kg/year	71,900 kg/year
8654 TJ/year	8650 TJ/year

It is imperative to understand the EEA does not have the mandate to change values, the application of this rule is therefore solely the operators' responsibility.

2.2.2 Confidentiality

All the data contained by the E-PRTR+LCP Thematic Data Flow may be considered confidential if desired. The reasons for data to be considered confidential are those recognised by EU law, namely Directive 2003/4/EC on public access to environmental information. Under the previous E-PRTR reporting mechanism, confidential data was withheld from the data submission to the EEA, however under the EU Registry/E-PRTR + LCP Integrated Reporting mechanism the confidential data must now be transmitted to the EEA. The EEA will put in place measures to ensure that data designated as confidential are not disclosed to the public. A valid reason as to why the data are confidential must be provided for each piece of data that is desired to be considered confidential (e.g. Article 4(2)(a): '*Disclosure of the information would adversely affect the confidentiality of the proceedings of public authorities, where such confidentiality is provided for by law, in accordance with Directive 2003/4/EC.*').

The mechanism for expressing a claim of confidentiality is facilitated by the confidentialityReason attribute within the E-PRTR+LCP Thematic data model. When this attribute is populated with a reason from Directive 2003/4/EC in the applicable data type, then the attributes within the feature type or data type are protected and will not be published by the EEA in public data products. This attribute appears in all feature types visible in Figure 7, this gives the user complete control as to what aspects of the data for which confidentiality is desired. It should be noted that QAQC checks will ensure confidentiality will not be used to an excessive extent, and those member states which submit data with confidentiality beyond what is reasonably anticipated will be queried bilaterally by the EEA.

If reporting countries have confidential data in their files for submission, then they must choose the 'restricted from public view' tick box when uploading the file into the envelope, otherwise the XML file will be available for public viewing in the envelope. If this box is not ticked at the time of uploading, then the file will have to be deleted and uploaded again in order to restrict from public view.

2.2.3 Common stack principle for combustion plants

The rules which establish the common stack principle are stated within IED Article 29:

Art 29(1): *Where the waste gases of two or more separate combustion plants are discharged through a common stack, the combination formed by such plants shall be considered as a single combustion plant and their capacities added for the purpose of calculating the total rated thermal input.*

Art 29(2): *Where two or more separate combustion plants which have been granted a permit for the first time on or after 1 July 1987, or the operators of which have submitted a complete application for a permit on or after that date, are installed in such a way that, taking technical and economic factors into account, their waste gases could in the judgement of the competent authority, be discharged through a common stack, the combination formed by such plants shall be considered as a single combustion plant and their capacities added for the purpose of calculating the total rated thermal input.*

Art 29(3): *For the purpose of calculating the total rated thermal input of a combination of combustion plants referred to in paragraphs 1 and 2, individual combustion plants with a rated thermal input below 15 MW shall not be considered.*

Further guidance on this concept has been provided in the ‘Compilation of common questions on Large Combustion Plants (LCP) reporting’ document³. Two key principles are outlined in this document, the ‘real total rated thermal input’ and the ‘capacity for legal purposes’. Whilst the real thermal input takes into account all combustion units operating, including those below 15 MWth, the capacity for legal purposes only aggregates combustion units above 15 MWth, as mandated by Article 29 (3). If the capacity for legal purposes is equal to or greater than 50 MWth, then the aggregated units are considered a single LCP installation part which is within the scope of Article 72 of the IED. Once an LCP installation part is obliged to report under Article 72 of the IED, both the capacity and the emissions to be reported are those that correspond to the real-life situation, i.e. the real total rated thermal input, the real fuel input and the real emissions.

In summary, reporters must calculate whether a group of combustion units are required to be reported as an LCP installation part under the IED **using combustion units above 15MWth only**. However, if the aggregated combustion units qualify as an LCP installation part, **reporters must report the total rated thermal input, fuel input and emissions from all combustion units including those below 15MWth**. outlines several potential scenarios for reporting data under the common stack principle. Only scenario ‘A’ is considered an LCP installation part, whilst two combustion units are to be included in the capacity for legal purposes, all combustion units should be included in the reporting of aggregated total rated thermal input, energy input and emissions. Neither scenario ‘B’ nor ‘C’ is defined as an LCP installation part by the IED because the aggregated capacity for legal purposes is below 50 MWth in both cases.

³ http://cdr.eionet.europa.eu/help/lcp/Questions_LCP.pdf

Figure 3 - Example scenarios for implementation of the common stack principle

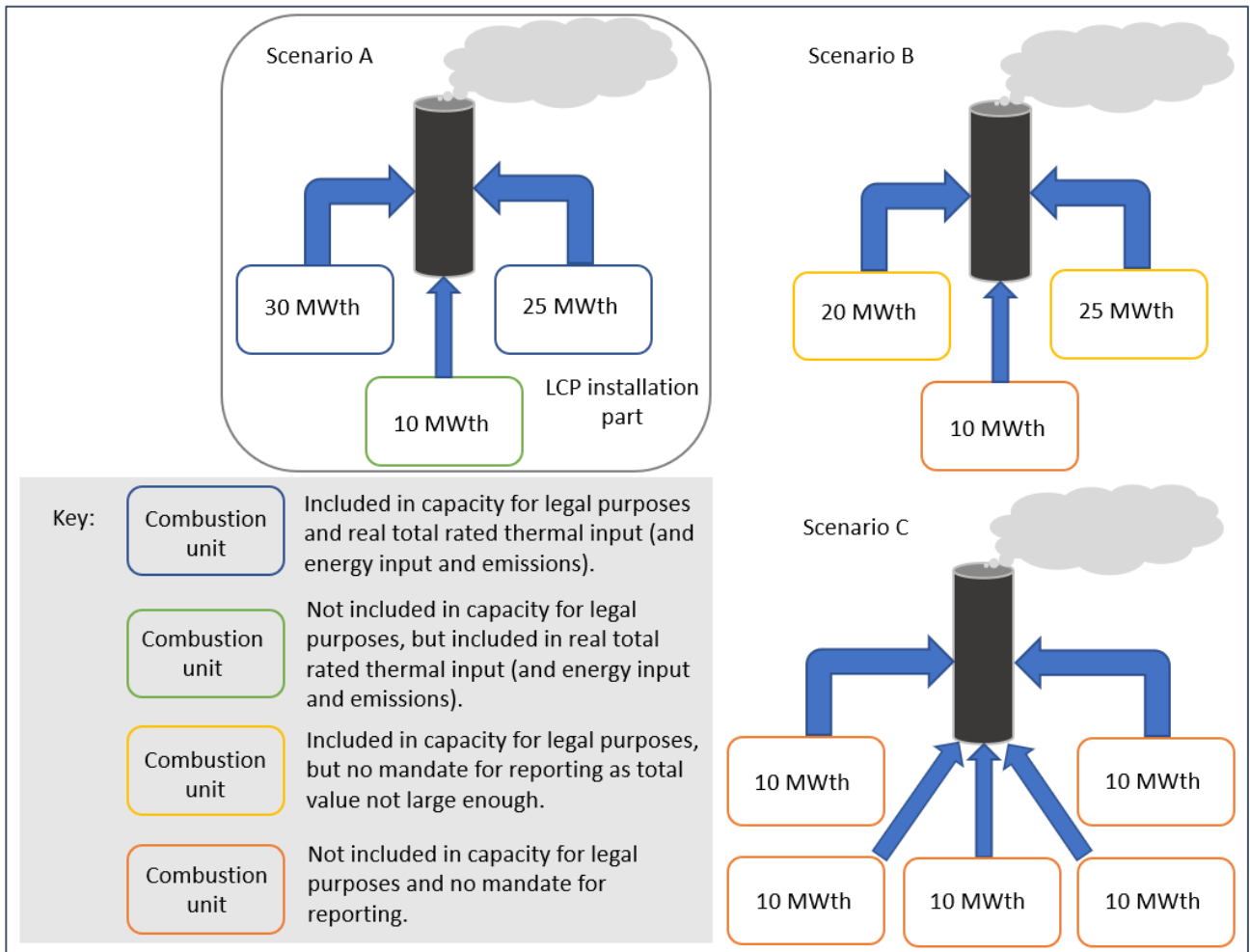

The aggregation of combustion plants has implications for several aspects of reporting, details of affected attributes are outlined in Table 2.

Table 2 - Attributes affected by the common stack principle

Attribute	Approach
combustionPlantCategory	If two or more of the combustion units aggregated are classified differently according to the CombustionPlantCategoryValue code list, the attribute should be populated according to the classification of the combustion unit with the largest thermal input.
numberOfOperatingHours	The number supplied within this attribute should reflect the number of hours where at least 1 of the combustion units was operational, including combustion units below 15 MWth. If two or more combustion units operate at the same time, the hours should not be duplicated to reflect each individual unit e.g. 2 combustion units operating for 1 hour = 1 hour of operation not 2. The total number of reported operating hours should not exceed the maximum hours for one year (8784).
withinRefinery	The Boolean should be set to true if any of the combustion units are set within a larger refinery site.
proportionOfUsefulHeatProductionForDistrictHeating	The proportion should be calculated based upon the useful heat production of all units combined.
energyInputTJ	The energy input should reflect the total of all combustion units (including units < 15 MWth) combined for the specific fuel.
totalPollutantQuantityTNE	The total should reflect the emissions of all combustion units (including units < 15 MWth) combined.

2.2.4 Code lists

Code lists within the E-PRTR+LCP Thematic Data Model are used to specify and control the population of attributes which pertain to a limited set of concepts e.g. LCP installation part pollutants. Where an attribute needs to be populated with a code list value, **INSPIRE compliance mandates that the full URL must be supplied.** This full URL must be included in the reported file, for example, the full code list for the E-PRTR Pollutant Code Value for NOx must be included as per the data dictionary full URL:

- <http://dd.eionet.europa.eu/vocabulary/EPTRandLCP/EPTRPollutantCodeValue/NOx>

Certain code lists have been duplicated across the EU Registry and the E-PRTR-LCP thematic data flows, e.g. country codes. Although both sets of lists contain the same values, they are housed in separate data dictionaries and as such have different root URLs. Reporters must use the appropriate code list value when

reporting to either the EU Registry or the E-PRTR-LCP thematic data flows, there are QA/QC checks in place to ensure this is adhered to.

There are multiple code lists which contain concepts that are not specifically defined in the underlying legislation of the IED or the E-PRTR Regulation. In the interest of data quality, the EEA have undertaken the task of supplying recommended definitions for these concepts when they occur. To do this, the EEA undertook a review of relevant documentation and international definitions (e.g. the International Energy Agency definitions⁴). At the time of writing this document this exercise was undertaken for the following code lists: FuellInputValue, OtherGaseousFuelsValue, and OtherSolidFuelsValue. The definitions for the concepts included in these code lists can be accessed within the definition field of the 'EPTRandLCP' section of the [data dictionary](#). It should be noted that these definitions (excluding 'biomass' within the FuellInputValue code list) are considered as recommendations only, and have no basis within the underlying legislation considered in Section 1.3.

2.3 Reporting on Large Point Sources under the Convention on Long-range Transboundary Air Pollution (CLRTAP) and National Emissions Ceiling Directive (NECD)

Directive 2016/2284/EU ('the National Emissions Ceiling Directive') requires that, every four years from 2017 onwards, aggregated sectoral gridded emissions and large point source emissions shall be reported with reference to year-2, replicating the corresponding reporting requirement on parties to the LRTAP Convention. The reporting obligation in relation to large point sources is recorded in the Reporting Obligation database (ROD) as obligation 750⁵ for NECD reporting and 744⁶ for CLRTAP reporting. Detailed Guidance regarding the reporting of large point sources and this obligation is available from the Centre on Emission inventories and projection (CEIP) website⁷. This obligation can be seamlessly integrated with the E-PRTR+LCP due to the fact the large point source definition for NECD/LRTAP convention reporting is based upon those facilities which exceed the E-PRTR Regulation Annex II thresholds for releases to air for specified pollutants. Due to this overlap in scope definition, such an obligation provides an opportunity for further streamlining via integration within the E-PRTR+LCP data flow. It should be noted that this integration does not replace these reporting obligations, but rather voluntary reporting under this data flow can be used to fulfil the obligation, such that the integrated E-PRTR+LCP data is transferrable for NECD/LRTAP reporting. The following principles have been integrated into:

Stack height – Within the guidance for LRTAP reporting, stack height is referred to as the 'physical stack height'. This classification refers to the height from the bottom of the stack enclosure to the outlet, as opposed to effective stack height, which accounts for the height of the plume rise, in addition to the physical height. If the stack is located within a larger building, or structure, the physical stack height should account for the height of the building, in addition to the height from the outlet to the bottom of the enclosure. These distinctions are depicted in Figure 4. If an E-PRTR facility holds multiple installations with multiple stacks then

⁴ International Energy Agency, Balance Definitions, (2017), <https://www.iea.org/statistics/resources/balancedefinitions/>

⁵ <http://rod.eionet.europa.eu/obligations/750>

⁶ <http://rod.eionet.europa.eu/obligations/744>

⁷ Guidelines for Reporting Emissions and Projections Data under the Convention on Long-range Transboundary Air Pollution: http://www.ceip.at/fileadmin/inhalte/emep/2014_Guidelines/ece.eb.air.125_ADVANCE_VERSION_reporting_guidelines_2013.pdf

the height of the 'main stack', a stack that releases more than 50 % of total emissions, should be reported. E-PRTR facilities that do not have a main stack should report an average height of all other stacks that contribute to the emissions (releases to air) of LRTAP/NECD pollutants (namely SO_x, NO_x, CO, NMVOCs, NH₃, PM_{2.5}, PM₁₀, Pb, Cd, Hg, PAHs, PCDD/PCDF, HCB, PCBs). The stack height is reported via the `representativeStackHeightM` attribute, which is populated in metres.

Figure 4 - Depiction of physical stack height, in comparison to other stack and plume measurements

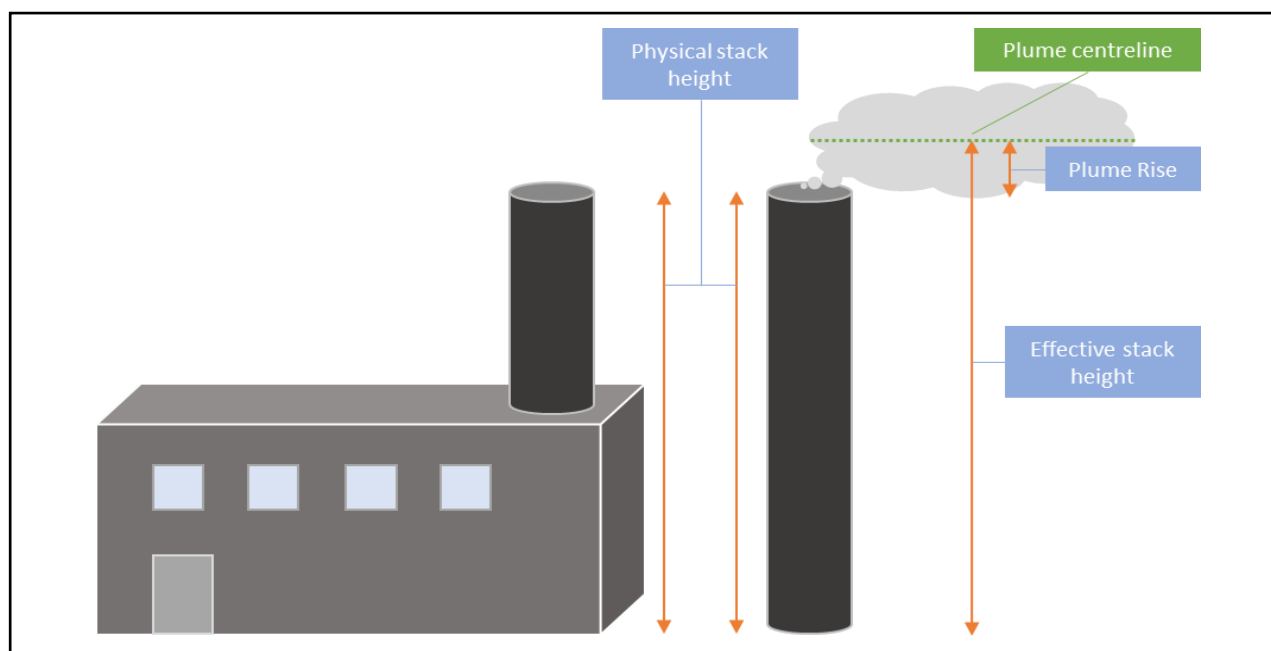

Reporting of Black carbon and PM_{2.5} – Two pollutants have been integrated into the `EPRTRPollutantValue` code list, hosted on the Eionet's data dictionary. These two pollutants are not currently reported under the E-PRTR, however reporting of PM₁₀ is included, and as a result the Annex II thresholds defined for PM₁₀ have been applied to PM_{2.5}. Black carbon (BC), in comparison, has no threshold defined under the CLRTAP. Reporting countries are therefore encouraged to report any quantities of BC released by the listed `ProductionFacilities` where available. The definition for BC can be found in Article 3(9) of the NECD and in section III of the Guidelines for Reporting Emissions and Projections Data under the CLRTAP⁷, and is defined as '*carbonaceous particulate matter that absorbs light*'.

2.4 Deadlines for reporting

Each XML submission to the E-PRTR+LCP Thematic Data Flow will need to contain all information for all applicable LCP installation parts and E-PRTR facilities in the reporting country for the relevant reporting year, above the Annex II or Article 5 thresholds. It will not be possible to submit data for just one LCP installation part or a subset of E-PRTR facilities. Partial data files therefore will not be accepted. This means that all entities subject to the E-PRTR+LCP Thematic Reporting and relevant to the reporting year are reported within each submission, as opposed to a subset of these entities where attributes and the data reported may have changed between reporting years (known as the 'management by change' approach).

The EEA will generally carry out the main data harvesting activities and generate a new dataset once a year, after the legal deadline (the deadline is currently 31st March, analogous to previous E-PRTR reporting, with reference to year x-2). Circumstances may arise where the EEA will generate additional versions in consultation with countries and the Commission. In practice, this means that both regular submission for a new year and resubmissions of pre-reported years will only influence the E-PRTR-LCP Thematic Reporting once a new version is generated by EEA.

The reporting is open all year long so that countries can interact with the system, organise themselves according to their own internal timelines and iteratively improve the reported data before the generation of the dataset by the EEA.

In case of quality issues in the reported data, countries could be required to resubmit their report on an ad hoc basis. Resubmissions of previously reported years will be allowed. However, changes in the dataset must be coherent with the data reported to the EU Registry, and where inconsistency is caused by a revision, a resubmission to EU Registry may also be necessary to re-align the data reported between the data flows.

All resubmissions will be full submissions of all industrial entities within a reporting year, partial submissions correcting specific entities will not be accepted. All resubmissions require the technical approval of the EEA. In the case of resubmissions this approval will be granted when they pass the mandatory validation and it can be ensured that the changes are not influencing previously reported data for the EU Registry.

3 Understanding the data model

3.1 Basic Terminology

This section focuses on the data model itself, and this requires a systematic walkthrough of all the attributes and components of the data model. The data model reflects the thematic reporting requirements of EU law in a systematic manner and defines how reports from countries are to be populated. As reporting is based on an IT tool, specific data modelling terminology is used in this chapter.

The IT tool is defined as follows:

- A data structure is modelled in Unified Modelling Language (UML)
- Reporters must prepare a file according to the UML either in Microsoft Access format or Extensible Markup Language (XML) format.

The Unified Modelling Language (UML) is a general-purpose modelling language that is intended to provide a standard way to visualise the design of a system. The data structure is designed in a structure diagram. The EEA only produced a so-called class diagram, one type of structure diagrams, which describes the objects that it contains and their relationships. The class diagram, together with a detailed explanation of each of the objects and attributes it contains, is presented in a feature catalogue. The objects are grouped in three main categories: Feature types, Data types and Code lists.

- Feature type – the generic terms used to describe a group of attributes within the UML. These are represented within the class diagram as boxes, which contain the phrase ‘«featureType»’. Feature types represent the highest level of aggregation in terms of the feature catalogue and contain other elements. The feature types therefore define the bounds of the core data structure.
- Data types – are similar to feature types, and contain a set of attributes to be populated, however they are intended to be more focused than that of feature types, with all attributes being used to detail a specific concept. These can be identified within the class diagrams via the phrase ‘type’ appended at the end of an attribute within a feature type or data type.
- Code lists – a defined set of values which can be used to populate an attribute. These can be identified within the class diagrams via the phrase ‘value’ appended at the end of an attribute within a data type or feature type. All code lists relevant to the E-PRTR+LCP Thematic Data Flow will be maintained in the EEA Data Dictionary which will permit prompt and efficient updating of these lists as necessary. The requirement to use the specified code lists should greatly help improve data quality since this will be a key part of a valid XML submission. The desired code list value must be submitted in the full context of the valid URL for the location where it is hosted within the [data dictionary](#). For example, to use ‘IT’ as the country code, the user must submit the URL:

[‘http://dd.eionet.europa.eu/vocabularyconcept/EPTRandLCP/CountryCodeValue/IT’](http://dd.eionet.europa.eu/vocabularyconcept/EPTRandLCP/CountryCodeValue/IT).

The E-PRTR+LCP Thematic Data Flow business rules are mainly included in the Unified Modelling Language (UML) data model and the Geographical Markup Language Encoding Standard (GML) Schema (XSD) when it comes to basic requirements such as field type and relationships. These business rules are in turn based upon key structural requirements for the E-PRTR+LCP Thematic Data Flow or requirements in the relevant legal instruments, such as whether provision of information is optional (e.g., text remarks providing additional information about a facility).

3.1.1 Multiplicity

Multiplicity in UML allows specifying the number of times a given attribute must be reported or the logic of a relationship between two objects (i.e. number of times an object is related to another).

The multiplicity applicable to each attribute is provided in the brackets at the very end of the attribute, containing two numbers. The first number indicates the number of iterations the attribute must occur, and the second is the upper limit of these iterations. A zero (0) indicates the attribute may not need occur and therefore can be left unpopulated. An asterisk (*) indicates an unlimited upper bound, therefore allowing as many iterations of the attribute as necessary. The multiplicity [0..*] therefore means the attribute may either be populated or not, and if it is populated, may occur as many times as necessary to align with national circumstances. Where multiplicity is not supplied at the end of the attribute, it should be assumed a [1..1] multiplicity applies. Applying the same rules, this means that the attribute must be populated and can only occur once. In some cases, the multiplicity of an attribute varies depending on other conditions. For example, the 'proportionOfUsefulHeatProductionForDistrictHeating' attribute has a multiplicity of [0..1] which means it can be left unpopulated. However, where the 'Article 35' derogation has been reported for an LCP installation part, this attribute becomes mandatory according to the IED. The details of such cases are outlined in Section 3.3 of this document and QAQC procedures are in place to ensure these multiplicities are correctly adhered to.

Table 3 - Example of multiplicity and the result for object and relationships

Multiplicity	Meaning for an object	Meaning for a relationship
[0..1]	The object can be empty or populated once.	The objects are either not related or there is a maximum of one object related.
[1..1]	The object can only be populated once	One object is precisely related to a single other object
[0..*]	The object can be empty, populated once or populated many times	One object can be either not related to another one, to a single one or to many other objects.
[1..*]	The object has to be populated at least once but could also be populated many times	One object can be either related to a single other object or to many others.
[12..12]	The object shall be populated exactly 12 times	12 objects must precisely relate to 12 others.

3.2 Structure of the E-PRTR-LCP Thematic Data Model

When the feature types of the data model are displayed, the data model was designed to fit into broad structural framework to aid the understanding of users. Two frameworks were devised, the 'Legislative framework' and a 'conceptual framework'. The breakdown of the attributes contained within these feature types and connected data types is detailed according to these frameworks.

Both frameworks begin, starting from the top of the diagram, with a contextual section. This section contains only one feature type, ReportData, which contains attributes pertaining only to the submission itself, not the entity specific data reported. The regulatory framework then splits the data model into two distinct sides, the 'LCP side' on the left fork and the 'E-PRTR side' right of the fork.

This represents the respective legal instruments from which the feature types and the attributes within them originate. This framework is depicted in Figure 5 below. This figure is indicative of the structure of the data model and simplifies the feature types to their name only, removing the attributes within them for clarity.

Figure 5 - The legislative framework of the E-PRTR-LCP Thematic Data Model

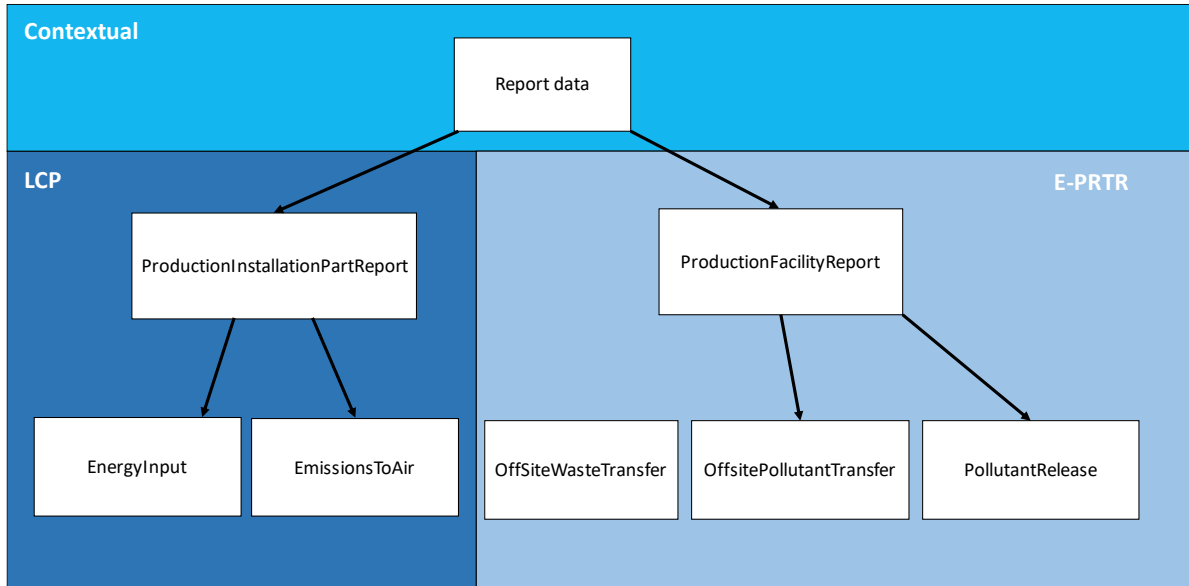

The conceptual framework differs in respect to the fact it has no consideration towards legal instruments but classifies the data model into tiers according to their direct relevance to industrial entities. Hence the data model can be broken down into general entity feature types, and those which pertain to specific concepts. Via this framework the data model can be viewed according to

Figure 6 - Conceptual framework of the E-PRTR-LCP Data Model

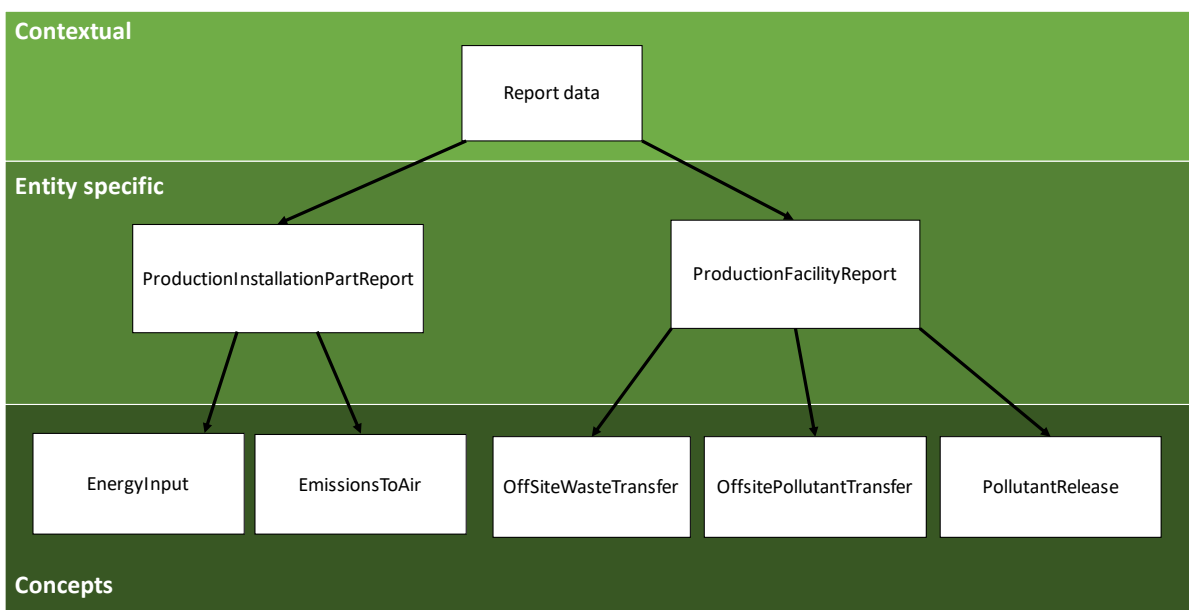

Figure 6 with the bottom tier representing the range of specific concepts detailed in both the IED and E-PRTR Regulation.

The following section will detail the attributes within the data model according to these frameworks, first addressing the LCP installation part side in its entirety before transitioning to the E-PRTR side. For each side, a separate diagram of all attributes will be produced, for the entity specific feature type, and also the concept feature types.

3.3 Content of the E-PRTR-LCP Thematic Data Model

The following section will detail the attributes within the data model according to the frameworks detailed in Section 3.2, first addressing the LCP installation part side in its entirety before transitioning to the E-PRTR side. For each side, a separate diagram of all attributes will be produced, for the entity specific feature type, and also the concept feature types. Each diagram will depict the feature type alongside the connected data types and code lists to provide a complete overview of all attributes to be populated. The feature types of the data model are depicted in the class diagram, Figure 7 below. In the following sections colour-coding is used to indicate whether an attribute is part of a **feature type** or a **data type** or the name of a **code list**. Guidance for each attribute is provided as they are introduced.

Figure 7 - Class diagram of the E-PRTR-LCP Thematic Data model.

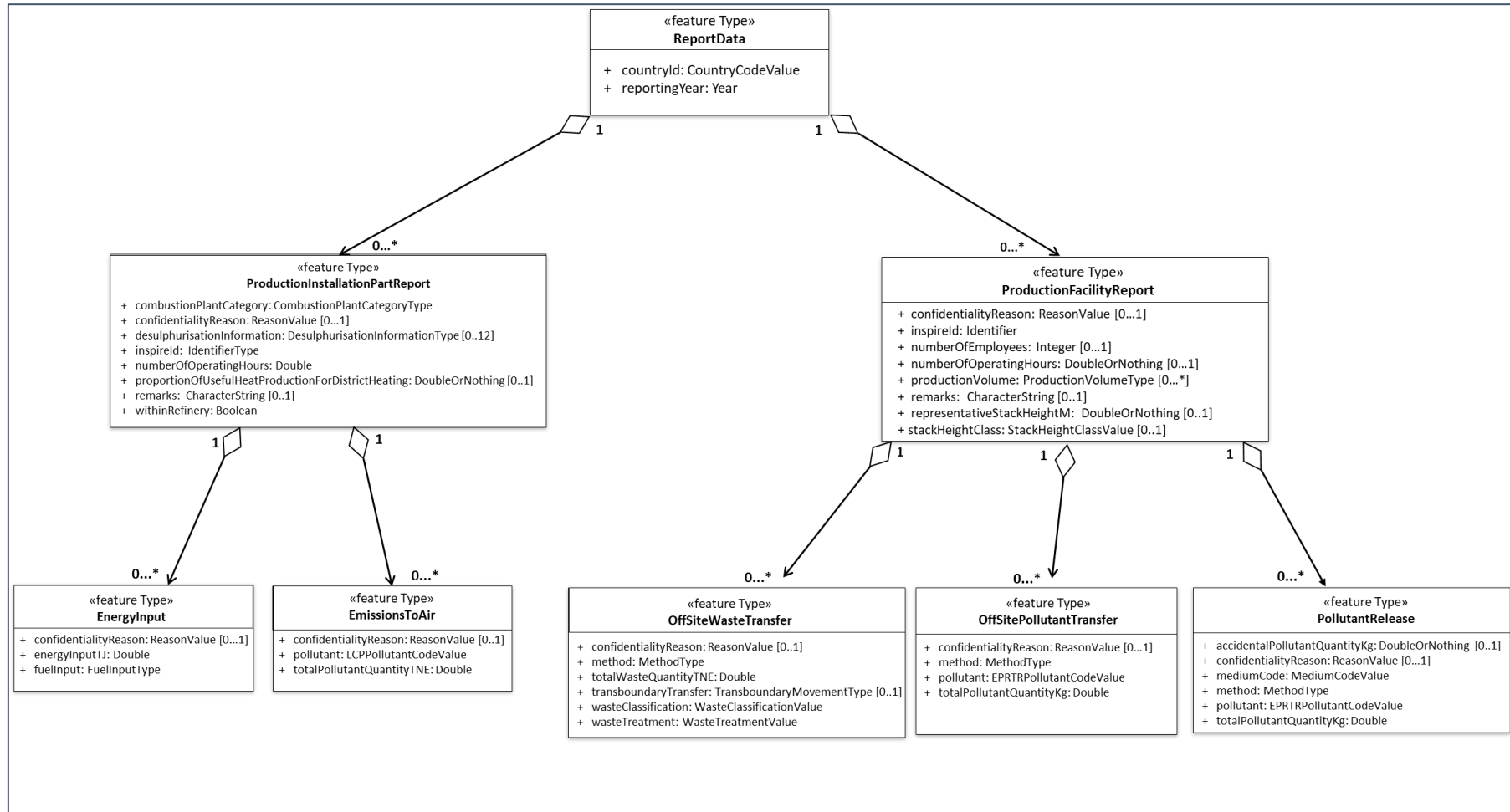

3.3.1 Report Data

Figure 8 - The ReportData feature type, alongside connected code lists.

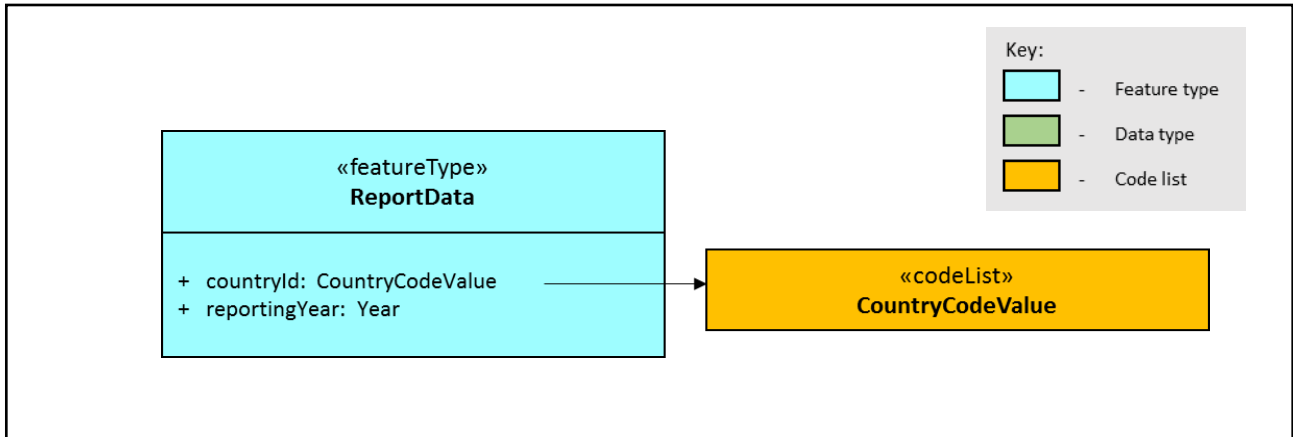

The *ReportData* feature type is to be reported only once for the whole XML submission from a country. It contains only two attributes that identify the source (country) and reporting year for a submission:

- **countryId** - is populated via a code list name the **CountryCode**. This consists of a list of two letter ISO-3166 codes of countries that will report to the EU Registry. An example would be the correct URL for where the code 'IT' for Italy or 'DE' for Germany is hosted in the EEA [data dictionary](#).
- **reportingYear** – Defines the year that the submission covers. The internal data harvesting process within the EEA database will produce a full European-wide dataset covering multiple years.

3.3.2 ProductionInstallationPartReport

Figure 9 - ProductionInstallationPartReport feature type alongside connected data types and code list

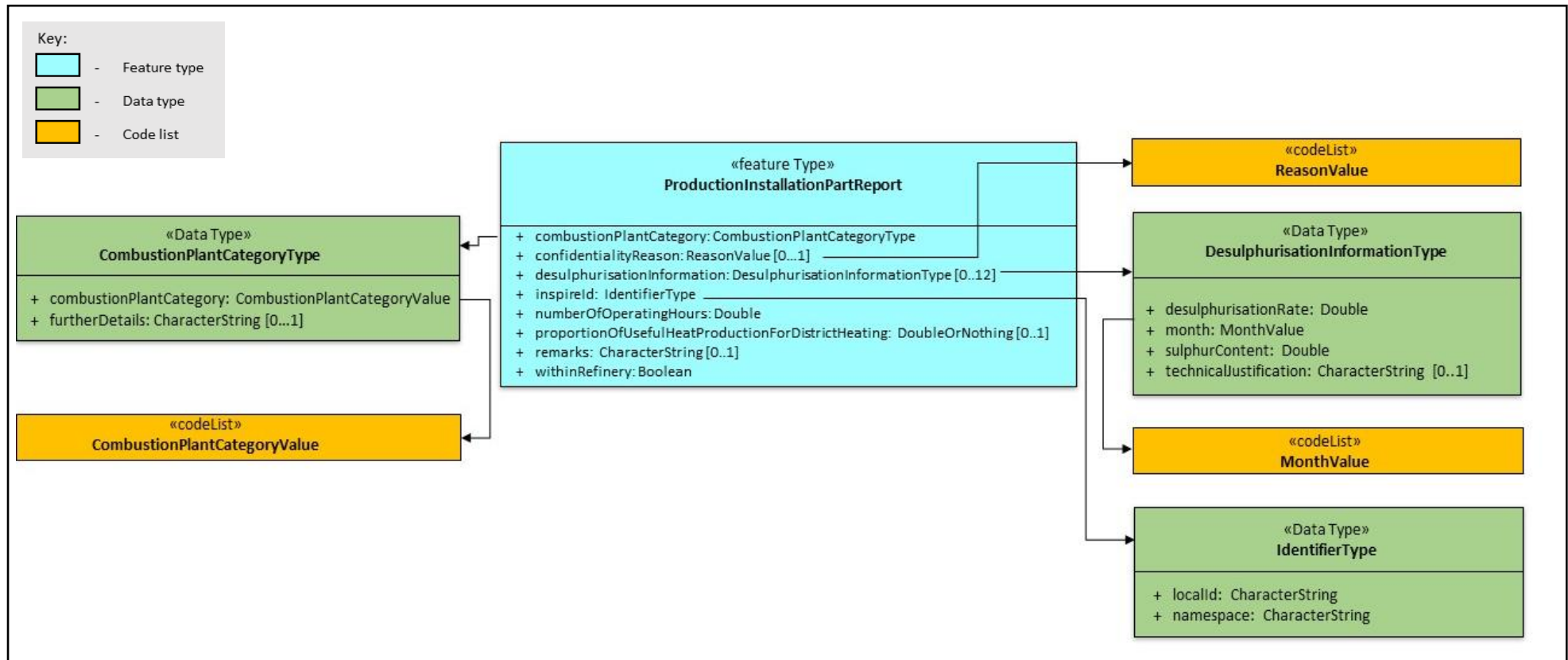

The *ProductionInstallationPartReport* feature type contains several attributes which detail general thematic data for an LCP installation part. The feature type is named after the *ProductionInstallationPart*, despite the fact the attributes only pertain to LCPs, to align with the naming used in the EU Registry and to imply the linkages depicted in Figure 2. The attributes are as follows:

- **combustionPlantCategory** – This attribute links through to the **CombustionPlantCategoryType** data type. This data type in turn contains only two attributes:
 - **combustionPlantCategory** – links through to the **CombustionPlantCategoryValue** code list. This code list in turn contains a range combustion plant types listed within Article 72 (3b) of the IED. Within these types is an option for ‘other (specifying the type)’. In scenarios where this value is used to populate this attribute, the **furtherDetails** attribute within the data type should be used to elaborate on the type of combustion plant, thus conforming to the requirements of the IED. Under the common stack principle, LCP installation parts with a common stack must be aggregated for reporting purposes. This aggregation will impact the way in which this attribute will be populated. For further detail on how to populate this attribute, see Section 2.2.3.
 - **furtherDetails** – This attribute is populated using a simple CharacterString. In scenarios where the above attribute is populated with the value ‘Others’, this attribute should be used to further elaborate on the type of combustion plant being reported. QAQC procedures will be in place to ensure this occurs. The attribute can also be used to further elaborate on the combustion plant itself, however this can be alternatively supplied within the remark attribute of the *ProductionInstallationPartReport* feature type.
- **ConfidentialityReason** - Populated using the **ReasonValue** code list. This is a list of multiple reasons for protecting sensitive information from release into the public domain and originates from the Directive 2003/4/EC on public access to environmental information. The multiplicity associated with this attribute results in the fact this attribute can be left unpopulated if not applicable. If this attribute is populated however, then the all the data for the specific LCP installation part associated with the *ProductionInstallationPartReport* feature type will be protected from being incorporated into public data products. This does not affect the confidentiality of associated feature types, e.g. *EmissionsToAir* or *EnergyInput*. Confidentiality for this data must be indicated separately. QAQC procedures will evaluate whether claims for confidentiality exceeds an unacceptable degree, relative to the total submission. Claims for confidentiality, therefore, are anticipated to only apply to rare select cases.
- **desulphurisationInformation** – This attribute links through to the **DesulphurisationInformationType** data type. This is designed to supply the required information mandated under Article 72 (4a) of the IED, which in turn details the necessary data when a combustion plant reports as being subject to derogation under Article 31 of the IED. Derogations are separately reported in the EU Registry, and therefore there should exist alignment with the population of the ‘derogations’ attribute of the *ProductionInstallationPartReport* with the LCP installation part of the same inspireId reported within this data flow. In scenarios where the derogation attribute of the EU Registry is populated with ‘Article 31’, the following attributes must be populated. QAQC procedures will ensure this is adhered to.
 - **desulphurisationRate** – The rate of desulphurisation achieved, in regard to the original sulphur content of the indigenous solid fuel. Value should be supplied as a decimal value representing a percentage (e.g. 0.1 is equivalent to 10%)
 - **month** – Links to the **MonthValue** code list. This consists of a simple list of months within a year, which aligns with the multiplicity [0..12] of the data type. As the values above are

required to be supplied as an average over each month, the data type must be populated once for each month in the code list, even in scenarios where the combustion plant may be disused, or only began operation during a specific portion of the reporting year. QAQC procedures will also be employed to ensure each month is only reported once for a reporting year.

- **sulphurContent** – Sulphur content of the indigenous solid fuel. Value should be supplied as a decimal value representing the percentage dry weight (e.g. 0.1 is equivalent to 10%).
- **technicalJustification** - the technical justification of the non-feasibility of complying with the emission limit values referred to in Article 30(2) and (3) of the IED. This must be supplied for the first year where derogation under Article 31 is applied. The multiplicity used [0..1], allows for when the first year of the derogation has passed. QAQC procedures will ensure that when the derogation is first reported in the EU Registry, the thematic submission under the E-PRTR-LCP Thematic Data Flow will be consistent with the IED by ensuring this attribute has been populated.

QAQC procedures will be in place to ensure that this information is supplied when Article 31 is reported for the ProductionInstallationPart within the EU Registry. Such information will also ensure at least one solid fuel is populated for the EnergyInput feature type, hence fulfilling the criteria set under this derogation.

- **inspireId** – This attribute should be populated using the **Identifiertype** data type with an identifier that is unique to the LCP installation part being reported. The **Identifiertype** data type consists of two attributes working in conjunction:
 - **localId** – Populated using a CharacterString, representing the second component of the inspireId for that LCP installation part. This may include a mixture of letters and numbers.
 - **Namespace** – Populated using a CharacterString, representing the first component of the inspireId. This too can include a mixture of letters and numbers.

The inspireId is advised to follow the requirements set out in Section 3.3 of the EU Registry on Industrial Sites [Manual for Reporters](#). The inspireId must also refer to an LCP installation part previously reported for the same reporting year within the EU Registry. QAQC procedures will be in place to ensure the inspireId specified within the submission does in fact refer to a LCP installation part within the EU Registry, and therefore enables linkages to be made.

- **numberOfOperatingHours** – This attribute is populated with a positive real number in a double-precision floating-point format, referring to the hours of operation with the reporting year. This should be aligned with the hours for which the LCP installation part was combusting a fuel and no other definitions of operation. This must exclude shut-down and start up period where fuel is not combusted. In scenarios where the LCP installation part did not operate at any point within the reporting year (therefore no fuel was combusted), then the attribute is anticipated to be populated with **a zero value**. This is to reflect the mandatory nature of the attribute implied within the Article 72 (3e) of the IED. QAQC procedures will be in place to ensure this attribute is populated with an integer not greater than the possible hours in a year and will also highlight inconsistencies between the reported energy input and how this aligns with the reported operating hours. Under the common stack principle, LCP installation parts with a common stack must be aggregated for reporting purposes. In this case the number of operating hours should be calculated according to the time for which at least one of the LCP installation parts was operational. If two or more LCP installation parts were operational at the same instance, the hours should not be duplicated, for more information see Section 2.2.3.
- **proportionOfUsefulHeatProductionForDistrictHeating** – Populated using a decimal value representing the proportion of useful heat production of each plant which was delivered in the form of steam or hot water to a public network for district heating, expressed as a rolling average

over the preceding 5 years. In scenarios where this average is not available over the specified period, an annual average must be supplied, building in terms of period over the subsequent reporting years (e.g. 1st year of reporting – 1 year average, 3rd year of reporting – 3 year rolling average). The percentage supplied should be greater than 50% in order to qualify under the criteria for the derogation under Article 35 of the IED, where this requirement originates. QAQC procedures will evaluate the alignment between the 'derogations' attribute of the EU Registry and the population of this attribute. In scenarios where the derogations attribute for a ProductionInstallationPart within the EU Registry is populated with 'Article 35', the LCP installation part of the same inspiereId must have this attribute populated, with a value greater than 50%. Under the common stack principle, LCP installation parts with a common stack must be aggregated for reporting purposes. Under these circumstances this percentage will be calculated based upon all LCP installation parts which share the common stack relative to their own heat production, for more information see Section 2.2.3.

- **Remarks** – An attribute to be populated with a CharacterString, to enable the user to supply any additional information of interest to the EEA and the Commission regarding the LCP installation part reported. Such an attribute may be used to supply further information concerning any of the above attributes i.e. explanation regarding low operating hours.
- **withinRefinery** – An attribute populated using a Boolean. If the Boolean is set to true, then this indicates that the combustion plant reported is located within a refinery. If this is not true, the Boolean should be set to false. This mechanism is designed to fulfil the obligation listed in Article 72 (3), to allow the identification of those combustion plants within refineries, in inventory summaries to be produced by the EU Commission every 3 years.

3.3.3 EnergyInput

Figure 10 - EnergyInput feature type alongside connected data type and code lists

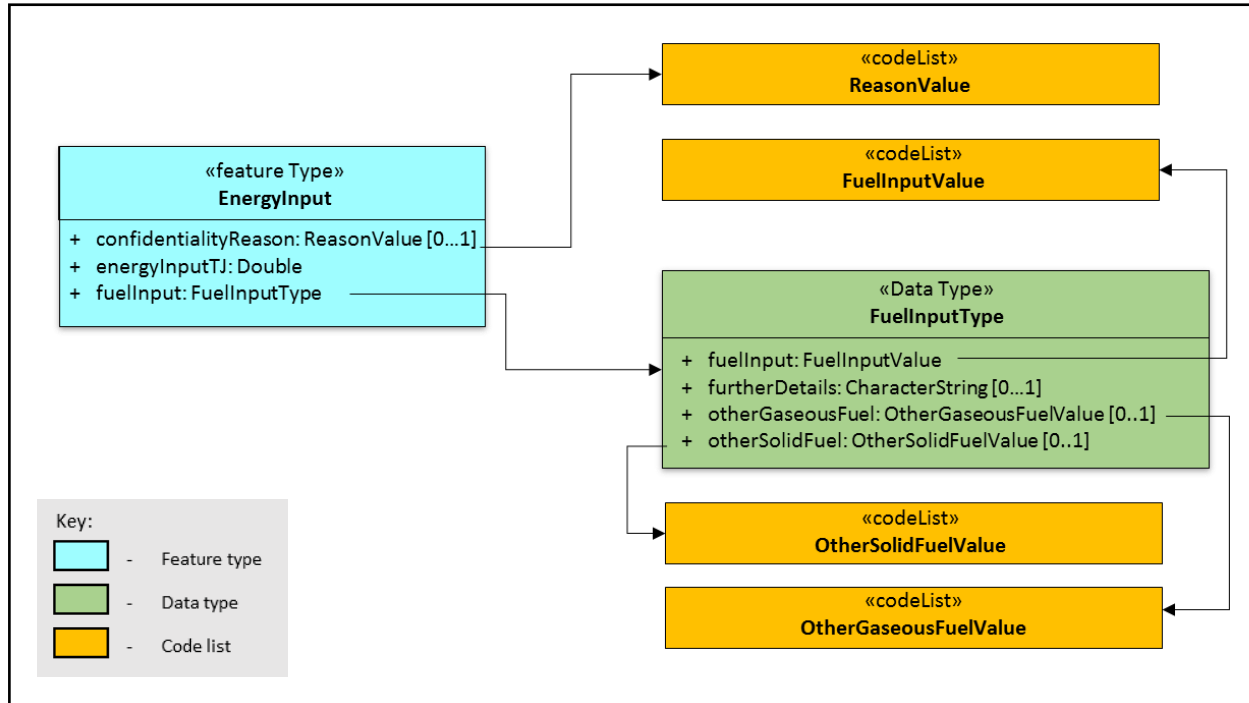

The *EnergyInput* feature type, is the first of the concept feature types on the LCP installation part side of the data model. All attributes within the feature type are used to detail the energy input requirements of Article 72 (3f) of the IED. It contains only 3 attributes, one of which links through to a data type containing a further 4 attributes. This can be seen in below:

ConfidentialityReason - Populated using the **ReasonValue** code list. This is a list of multiple reasons for protecting sensitive information from release into the public domain and originates from the Directive 2003/4/EC on public access to environmental information. The multiplicity associated with this attribute results in the fact this attribute can be left unpopulated if not applicable. If this attribute is populated however, then the all the data for the specific fuel input being reported within this feature type will be protected from being incorporated into public data products. As this feature type is intended to be populated once for each fuel category combusted within the reporting year, supplying a reason value will protect specific fuels and their calorific values only. QAQC procedures will evaluate whether claims for confidentiality exceeds an unacceptable degree, relative to the total submission. Claims for confidentiality, therefore, are anticipated to only apply to rare select cases.

- **energyInputTJ** – Populated using a positive real number in a double-precision floating-point format representing the net calorific value of the fuel combusted. Such a value should be reported in terra joules and no other unit. Under the common stack principle, LCP installation parts with a common stack must be aggregated for reporting purposes. Under these circumstances, combustion plants should be reported as a single entity and therefore the energyInputTJ for specific fuels should be aggregated according to the types specified in the fuelInput attribute below.

- **fuelInput** – The fuelInput attribute refers to the **FuelInputType** data type. This in turn contains several attributes used to give context to the value populated in the ‘energyInputTJ’ attribute. The attributes are as follows:
 - **fuelInput** – Populated using the **FuelInputValue** code list. This list consists of the 8 fuel categories listed in Article 72 (3f) of the IED. Two of these categories are ‘other solid fuels’ and ‘other gases’. Under these options the IED states that the member state must specify the type, which has been facilitated via the ‘otherSolidFuel’ and ‘otherGaseousFuel’ attributes also within the data type. If either ‘other solid fuels’ or ‘other gaseous fuel’ is populated within this attribute it is anticipated that the user specifies the type of fuel using the respective attributes. Reported fuelInput values must remain unique. It is therefore not possible to for example report multiple “Coal” or “Biomass” fuelInputs. There may be cases where more than one “OtherSolidFuel” or “OtherGases” could technically be reported. Under these circumstances the energyInputTJ values should be aggregated and the most prominent fuel in the mix should be reported under OtherSolidFuelValue or OtherGaseousFuelValue.. The furtherDetails field should then also be completed with additional information about the particular mix of other fuels being combusted.
 - **furtherDetails** – A character string populated with further information pertaining to the fuel categories chosen. If the otherSolidFuel attribute or the otherGaseousFuel attribute is populated with ‘other’, this attribute should be used to specify the type of fuel being reported. QAQC procedures are in place to ensure this attribute is populated whenever this scenario occurs. Alternatively, if this isn’t the case the attribute may be used to supply further information about the fuel.
 - **otherGaseousFuel** – Links through to the **otherGaseousFuelValue** code list. This is populated with further categories of gaseous fuels. This list is intended to adapt to reporting as further fuel types are identified and will be carefully monitored to ensure no duplication or similar categories occur. This attribute is only anticipated to be populated if the fuelInput attribute is populated using the value ‘other gaseous fuels’. If the contents of the code list does not consist of the gaseous fuel to be reported, the category ‘other’ should be populated and the user should specify the type of gaseous fuel using the ‘furtherDetails’ attribute within the data type.
 - **otherSolidFuel** – Links through to the **OtherSolidFuelValue** code list. This is populated with further categories of solid fuels. This list is intended to adapt to reporting as further fuel types are identified and will be carefully monitored to ensure no duplication or similar categories occur. This attribute is only anticipated to be populated if the fuelInput attribute is populated using the value ‘other solid fuels’. If the contents of the code list does not consist of the solid fuel to be reported, the category ‘other’ should be populated and the user should specify the type of solid fuel using the ‘furtherDetails’ attribute within the data type.

The *EnergyInput* feature type is required to be populated once for each fuel. The value reported should refer to a portion of the total for the specific fuel combination populated in the FuelInput attribute and not a calorific value for all fuels combusted. **The feature type should be populated for at least all 8 values contained within the FuelInputValue code list. In scenarios where the fuel was not combusted in the reporting year, the energyInputTJ value should refer to zero.** QAQC procedures will ensure this is adhered to.

3.3.4 EmissionsToAir

Figure 11- The EmissionsToAir feature type alongside connected data type and code lists

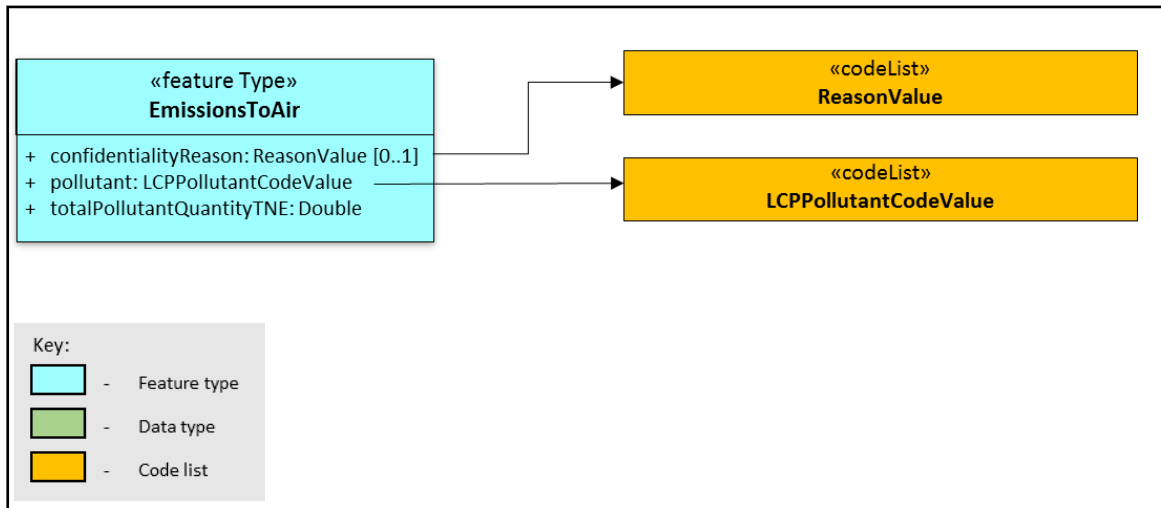

The *EmissionsToAir* feature type, is the second concept feature types on the LCP installation part side of the data model and contains attributes which solely refer to emissions. The attributes are as follows:

- ConfidentialityReason** - Populated using the **ReasonValue** code list. This is a list of multiple reasons for protecting sensitive information from release into the public domain and originates from the Directive 2003/4/EC on public access to environmental information. The multiplicity associated with this attribute results in the fact this attribute can be left unpopulated if not applicable. If this attribute is populated however, then the all the data for the specific emissions release being reported within this feature type will be protected from being incorporated into public data products. As this feature type is intended to be populated once for each pollutant specified in the IED, supplying a reason value will protect the individual pollutant and quantity reported only.
- Pollutant** – Populated using the **LCPPollutantCodeValue** code list. This code list in turn contains the three pollutants specified in Article 72 (3d) of the IED; sulphur dioxide, nitrogen oxides, and dust (total suspended particles). **The feature type must be populated once for each pollutant within the code list, even in scenarios where the specific pollutant is not emitted. This feature type will therefore be populated 3 times for any LCP installation part reported.** QAQC procedures will be in place to help enforce this repetition.
- totalPollutantQuantityTNE** – Populated with a positive real number in a double-precision floating-point format referring to the total quantity emitted in the reporting year. The quantity should be reported in **metric tonnes** and no other unit. Metric tonnes is the unit mandated by Article 72 (3d) of the IED. This value is given context by the pollutant attribute below. **If the pollutant referred to by the pollutant attribute, was not emitted within the reporting year, this attribute should be populated with a zero value.** Under the common stack principle, LCP installation parts with a common stack must be aggregated for reporting purposes. Under these circumstances, the quantity emitted should also be aggregated if calculated separately for each LCP installation part that shares the common stack. Such methodology should avoid duplication of emission values.

3.3.5 ProductionFacilityReport

Figure 12 - The ProductionFacilityReport feature type alongside connected data type and code lists

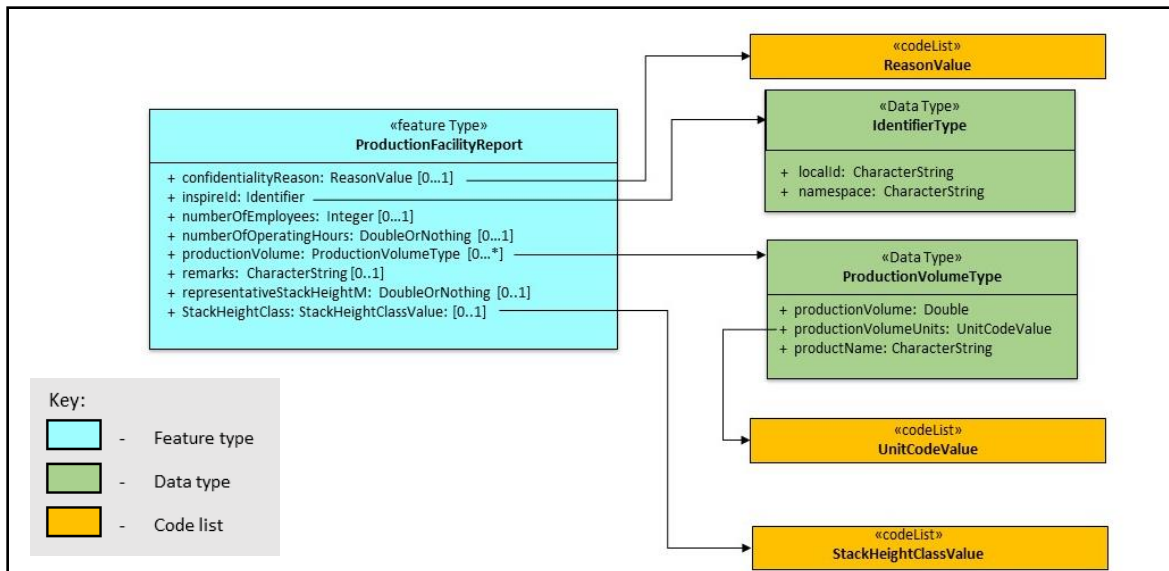

The *ProductionFacilityReport* feature type contains several attributes which detail general thematic data for an E-PRTR facility. This feature type along with all feature types on the E-PRTR side of the data model need only be populated if there is thematic data to report for a specific facility. This can be determined from the various thresholds in the E-PRTR Regulation (e.g. Annex II for Pollutant releases, or Article 5 for waste transfers). If no relevant thresholds are exceeded the user may still populate several attributes voluntarily.

- **ConfidentialityReason** - Populated using the **ReasonValue** code list. This is a list of multiple reasons for protecting sensitive information from release into the public domain and originates from the Directive 2003/4/EC on public access to environmental information. The multiplicity associated with this attribute results in the fact this attribute can be left unpopulated if not applicable. If this attribute is populated however, then the all the data for the specific E-PRTR facility associated with the ProductionFacilityReport feature type will be protected from being incorporated into public data products. This does not affect the confidentiality of the associated features types, e.g. PollutantReleases or OffsitePollutantTransfers. Confidentiality for this data must be indicated separately.
- **inspireId** – This attribute should be populated using the **IdentifierType** data type with an identifier unique to the E-PRTR facility being reported. The **IdentifierType** data type consists of two attributes working in conjunction:
 - **localId** – Populated using a CharacterString, representing the second component of the inspireId for that E-PRTR facility. This may include a mixture of letters and numbers.
 - **Namespace** – Populated using a CharacterString, representing the first component of the inspireId. This too can include a mixture of letters and numbers.

The inspireId should also refer to an E-PRTR ProductionFacility previously reported for the same reporting year within the EU Registry. The inspireId in turn has a series of criteria which

should be followed, and is detailed further in Section 3.3 of the EU Registry [Manual for Reporters](#). QAQC procedures will be in place to ensure the inspireId specified within the submission does in fact refer to a ProductionFacility within the EU Registry, and therefore enables linkages to be made.

- **numberOfEmployees** - Populated using an integer referring to the number of employees for the specific E-PRTR facility being reported. This attribute has a multiplicity of [0..1], reflecting it's 'optional' status in Annex III of the E-PRTR Regulation. As such, this attribute can be left un-populated if data are not available.
- **numberOfOperatingHours** – Populated using a positive real number in a double-precision floating-point format referring to the hours of operation in the reporting year. This attribute has a multiplicity of [0..1], reflecting it's 'optional' status in Annex III of the E-PRTR Regulation. As such, this attribute can be left un-populated if data are not available.
- **ProductionVolume** – This attribute links through to the **ProductionVolumeType** data type. This attribute has a multiplicity of [0..*], reflecting it's 'optional' status in Annex III of the E-PRTR Regulation. As such, this attribute can be left un-populated if data are not available. The attribute may also be populated multiple times to reflect scenarios where the E-PRTR facility creates several distinct products. The data type in turn consists of 3 attributes all pertaining to the concept of production volumes:
 - **productionVolume** – This attribute is populated using a positive real number in a double-precision floating-point format and should refer to the quantity of that product created within the reporting year. This should be supplied in terms of unit specified within the ProductionVolumeUnits attribute.
 - **productionVolumeUnits** – Links through to **UnitCodeValue** code list. This consists of a range of units that in turn give context to the value supplied in the above attribute. The user should use whatever unit is most appropriate to the product reported.
 - **productName** – This attribute is populated by a CharacterString, meaning the user is free to define the name of their product without control by a mechanism such as a code list. This was done intentionally due to the amount of products possible under the E-PRTR Regulation, indicated by the amount of activities listed in Annex I of the Regulation itself.
- **remarks** – this attribute is populated using a CharacterString and should pertain to any additional information regarding the thematic aspects of the E-PRTR facility reported. More generalised information regarding the identification or ownership of the facility should be supplied in the comparative field within the ProductionFacility feature type of the EU Registry data model.
- **representativeStackHeightM** – this attribute originates from the reporting requirements of the Convention on Long Range Transboundary Air Pollution (CLRTAP), and is a key parameter in the modelling of emissions from large point sources. This attribute is the physical stack height and should be measured from the bottom of the stack enclosure to the top of the outlet and reported as a positive real number in meters in a double-precision floating-point format. Further detail on this attribute can be found in Section 2.3 and in the examples in Annex 3 – Examples of reporting. The attribute is subject to [0..1] multiplicity and therefore does not need to be populated. Such multiplicity is designed to reflect the fact that, whilst this information is pertinent to air quality modelling, it is not mandated by Annex III of the E-PRTR Regulation.
- **stackHeightClass**: This attribute will define the stack height classification and will refer to the **StackHeightClassValue** code list. This is an optional attribute with a multiplicity of [0..1].

3.3.6 OffSiteWasteTransfer

Figure 13 - The OffSiteWasteTransfer feature type alongside connected data type and code lists

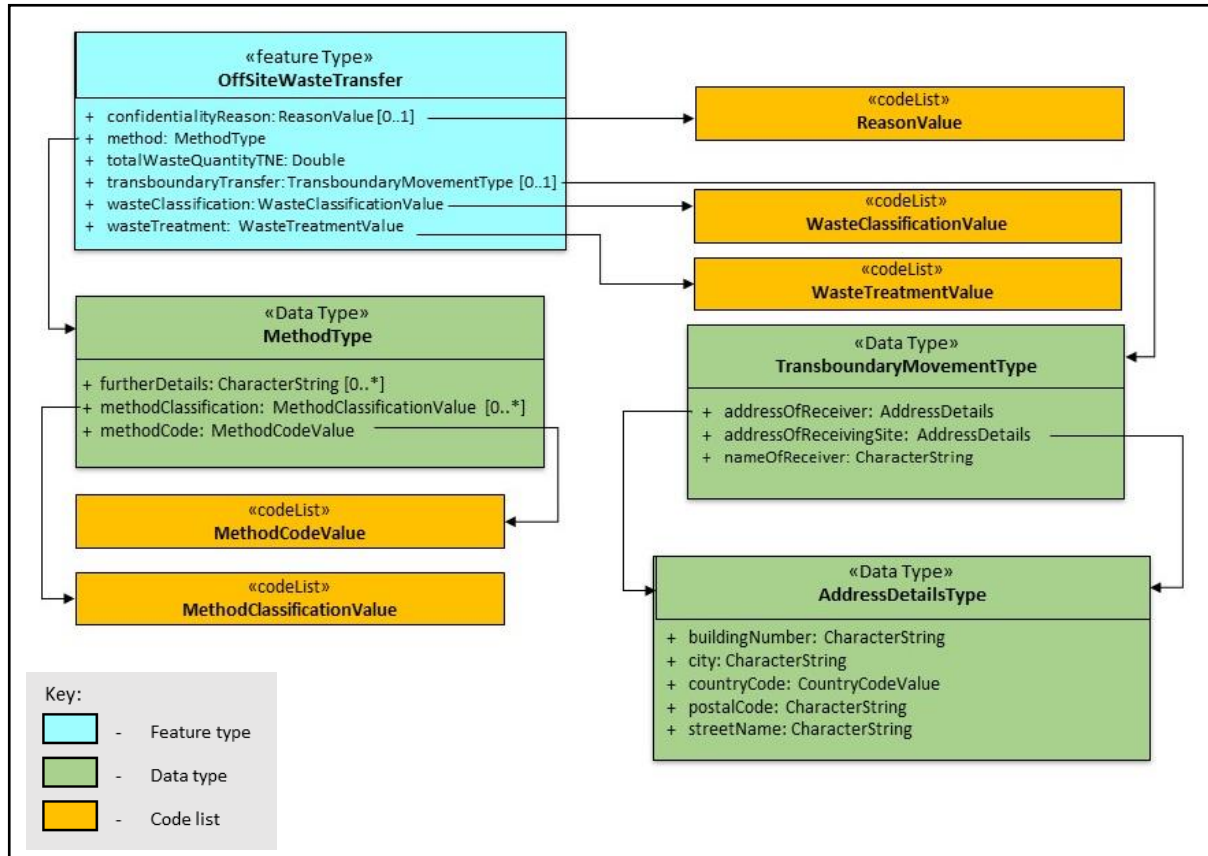

The OffSiteWasteTransfer feature type is the first of the concept feature types on the E-PRTR side of the data model. This feature type should be populated as many times as necessary, in relation to waste transfers above the thresholds specified in Article 5 of the E-PRTR Regulation.

- **ConfidentialityReason** - Populated using the **ReasonValue** code list. This is a list of multiple reasons for protecting sensitive information from release into the public domain and originates from the Directive 2003/4/EC on public access to environmental information. The multiplicity associated with this attribute results in the fact this attribute can be left unpopulated if not applicable. If this attribute is populated however, then the all the data for the specific waste transfer being reported within this feature type will be protected from being incorporated into public data products. As this feature type is intended to be populated once for each waste type and treatment combination, supplying a reason value will protect all the data associated with the reported individual waste transfer, e.g. quantity, method, classification, treatment etc.
- **method** – The method attribute in turn links through to the **MethodType** data type. This data type contains all the necessary detail mandated under Annex III when a value is reported under the E-PRTR Regulation. In this case this value refers to the quantity of waste reported

in the transfer, as reported in the totalWasteQuantityTNE attribute. The data type contains the following attributes:

- **furtherDetails** – A CharacterString attribute which enables the user to add any further necessary detail regarding the methodCode and methodClassificationCode. In scenarios where the methodClassificationCode has been populated using the value 'OTH' referring to other measurement/calculation methodologies, this attribute should be populated further elaborating on the name and nature of this methodology.
- **methodClassification** - Populated via the **MethodClassificationValue** code list. This in turn further classifies the method used to derive the quantity of the transfer. Article 5 of the E-PRTR requires that analytical method and/or the method of calculation shall be reported if the data is indicated as being based on measurement or calculation. Therefore, this attribute is required where the **methodCode** is reported as 'M' or 'C'. QAQC procedures will ensure this alignment is adhered to. Certain combinations are also not allowed. For example, if the methodCode is populated with the value 'M' referring to measured, the methodClassificationCode should refer to a measurement method classification such as 'WEIGH' (weighing), and not a classification which aligns with a different methodCode. The multiplicity for this attribute is [0..1], reflecting the fact this attribute is not required to be populated if the **methodCode** attribute is populated with 'E'.
- **methodCode** – Populated via the **MethodCodeValue** code list. This code list in turn classifies the transfer in terms of whether the quantity was estimated, calculated or measured.

totalWasteQuantityTNE – The quantity of the waste transfer reported. This should be reported as a positive real number in a double-precision floating-point format in units of **metric tonnes** and no other unit. This is the unit mandated in Annex III of the E-PRTR Regulation.

- **transboundaryTransfer** - This attribute links through to the **transboundaryMovementType** data type, in turn containing all the necessary attributes necessary in a scenario where the transfer of waste is to another country. According to Annex III of the E-PRTR, these attributes are only mandated in scenarios where the transfer consists of hazardous waste, as reported in the wasteClassification attribute. Under these circumstances the names of the recoverer or disposer, in addition to further address details is required. To avoid unnecessary duplication, attributes that detail the addresses and names of the recoverer and disposer respectively have not been used, but rather a single set of name and address attributes have been implemented referred to in terms of the receiver. Whether the receiver is the recoverer or the disposer will be interpreted according to the value populated in the wasteTreatment attribute above. If 'D' is populated within the wasteTreatment attribute, then any information given in the **transboundaryMovementType** data type will be interpreted as regarding the disposer. The data type contains the following attributes:
 - **addressOfReceiver** – The address of the receiver is supplied by a further **AddressDetails** data type. This should be populated in terms of the registered address for that company or individual receiving the transfer. It contains the following attributes:
 - **streetName**: the name of the street or road where the facility is located.
 - **buildingNumber**: The number associated to the building. This attribute can also be used to detail a building name, if this is more appropriate.
 - **city**: the city or region where the receiver is registered.

- postalCode: the postal code registered for the receiver.
 - addressOfReceivingSite – This attribute, similarly to the above, also refers to the AddressDetails data type. In this attribute, however, the details of the physical site receiving the transfer should be detailed, as opposed to the address registered to the company or individual.
 - nameOfReceiver - the name of the company or individual receiving the waste transfer in another country. This attribute is populated using a simple CharacterString.
- wasteClassification – Populated using the wasteClassificationValue. This in turn classifies the transfer according to the whether it is hazardous or non-hazardous in nature.
- wasteTreatment – Populated using the WasteTreatmentValue code list. This in turn classifies the transfer in terms of its intended destination type; recovery or disposal.

3.3.7 OffSitePollutantTransfer

Figure 14 - The OffSitePollutantTransfer feature type alongside connected data type and code lists

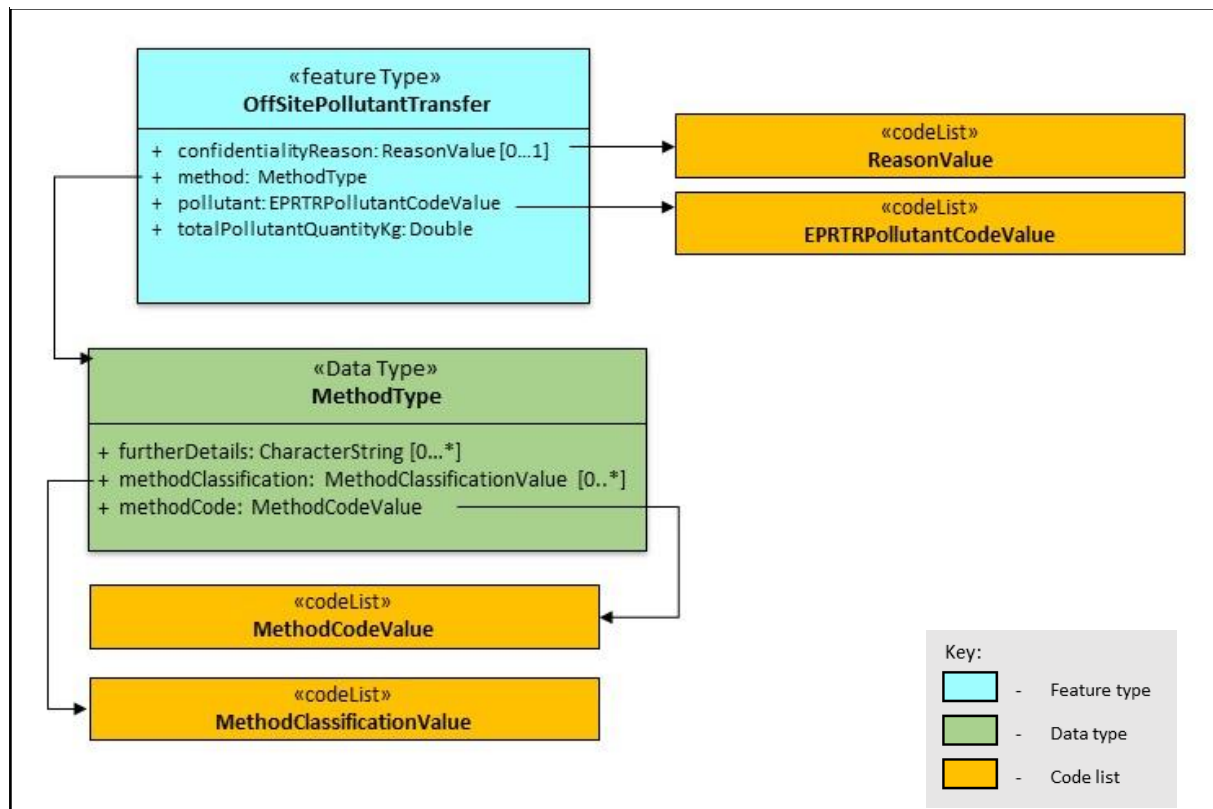

The `OffSitePollutantTransfer` feature type is the second concept feature type on the E-PRTR side of the data model and refers to the movement beyond the boundaries of a facility of pollutants in waste water destined for waste-water treatment. This should be populated if the off-site transfer of each pollutant destined for waste-water treatment is in quantities exceeding threshold values in Annex II of the E-PRTR Regulation.

- **ConfidentialityReason** - Populated using the **ReasonValue** code list. This is a list of multiple reasons for protecting sensitive information from release into the public domain and originates from the Directive 2003/4/EC on public access to environmental information. The multiplicity associated with this attribute results in the fact this attribute can be left unpopulated if not applicable. If this attribute is populated however, then the all the data for the specific pollutant transfer being reported within this feature type will be protected from being incorporated into public data products. As this feature type is intended to be populated once for each pollutant specified in the E-PRTR, supplying a reason value will protect all the data associated with the reported individual pollutant transfer, e.g. quantity, pollutant and method.
- **Method** - The method attribute in turn links through to the **MethodType** data type. This data type contains all the necessary detail mandated under Annex III when a value is reported under the E-PRTR Regulation. In this case this value refers to the quantity across the reporting year of the pollutant contained within the transfer destined for waste-water treatment, as reported in the totalPollutantQuantityKg attribute. The data type contains the following attributes:
 - **furtherDetails** – A characterString attribute which enables the user to add any further necessary detail regarding the methodCode and methodClassificationCode. In scenarios where the methodClassificationCode has been populated using the value 'OTH' referring to other measurement/calculation methodologies, this attribute should be populated further elaborating on the name and nature of this methodology.
 - **methodClassification** - Populated via the **MethodClassificationValue** code list. This in turn further classifies the method used to derive the quantity of the transfer. Article 5 of the E-PRTR requires that analytical method and/or the method of calculation shall be reported if the data is indicated as being based on measurement or calculation. Therefore, this attribute is required where the **methodCode** is reported as 'M' or 'C'. QAQC procedures will look to ensure this alignment is adhered to. Certain combinations are also not allowed. For example, if the methodCode is populated with the value 'M' referring to measured, the methodClassificationCode should refer to a measurement method classification such as 'WEIGH' (weighing), and not a classification which aligns with a different methodCode. The multiplicity for this attribute is [0..1], reflecting the fact this attribute is not required to be populated if the **methodCode** attribute is populated with 'E'.
 - **methodCode** – Populated via the **MethodCodeValue** code list. This code list in turn classifies the transfer in terms of whether the quantity was estimated, calculated or measured.
- **Pollutant** – Populated via the **EPRTRPollutantCodeValue** code list. This in turn refers to all pollutants listed in Annex II of the E-PRTR Regulation.
- **totalPollutantQuantityKg** – The total quantity of the pollutant across the reporting year contained within transfers destined for waste water treatment. Such a value should be reported as a positive real number in a double-precision floating-point format in units of **kilograms** and no other unit.

3.3.8 PollutantRelease

Figure 15 - The PollutantRelease feature type alongside connected data type and code lists.

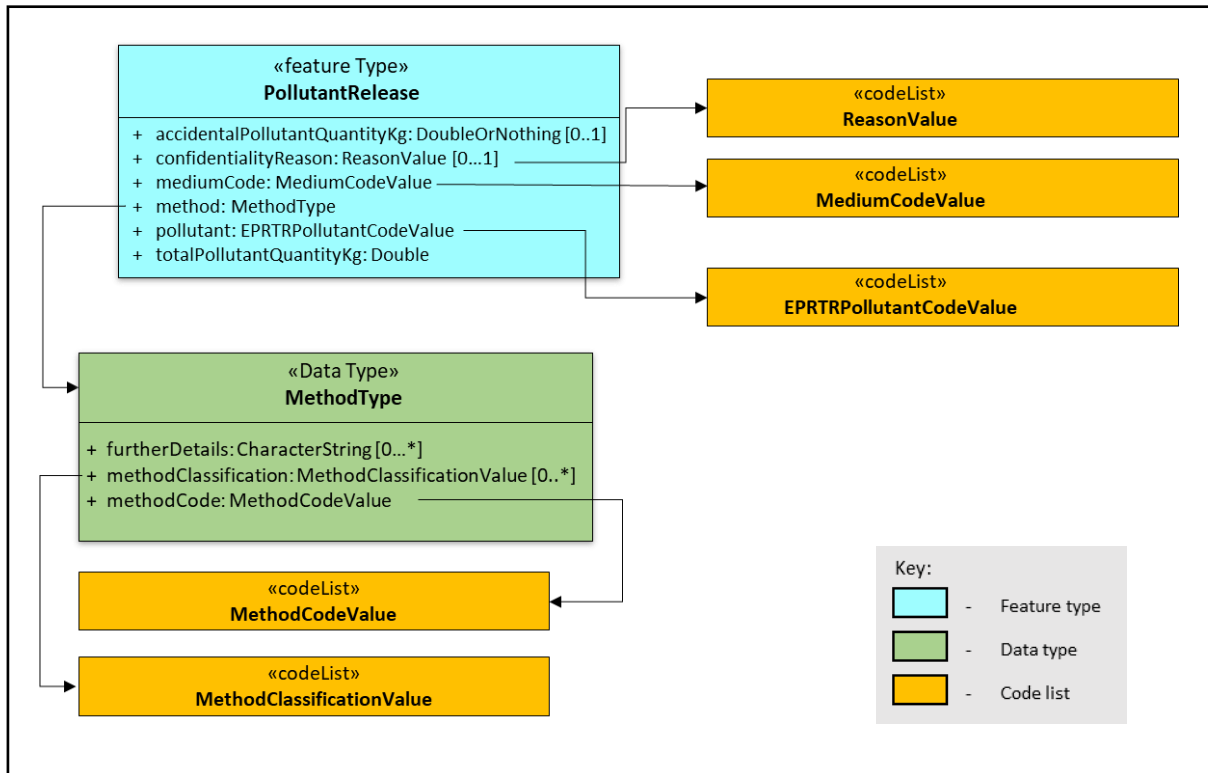

The PollutantRelease feature type is the final concept feature type on the E-PRTR side of the data model. This must be populated if the release of each pollutant is in quantities exceeding threshold values in Annex II of the E-PRTR Regulation. Voluntary reporting of pollutant quantities that do not exceed threshold values is also encouraged.

- **accidentalPollutantQuantityKg** – The total quantity released accidentally in the reporting year into the same medium for the pollutant referred to in the pollutant attribute. The value reported should be a positive real number in a double-precision floating-point format in units of kilograms and no other unit. The value should not be greater than the value reported in the totalPollutantQuantityKg attribute.
- **ConfidentialityReason** - Populated using the **ReasonValue** code list. This is a list of multiple reasons for protecting sensitive information from release into the public domain and originates from the Directive 2003/4/EC on public access to environmental information. The multiplicity associated with this attribute results in the fact this attribute can be left unpopulated if not applicable. If this attribute is populated however, then the all the data for the specific pollutant release being reported within this feature type will be protected from being incorporated into public data products. As this feature type is intended to be populated once for each pollutant specified in the E-PRTR, supplying a reason value will protect all the

data associated with the reported individual pollutant release, e.g. pollutant, medium, method, quantity etc.

- **mediumCode** – Populated using the **mediumCodeValue** code list. This contains the three possible mediums in which a release can occur; air, land and water.
- **Method** - The method attribute in turn links through to the **MethodType** data type. This data type contains all the necessary detail mandated under Annex III when a value is reported under the E-PRTR Regulation. In this case this value refers to the quantity across the reporting year of the pollutant released into the specified medium, as reported in the **totalPollutantQuantityKg** attribute. The data type contains the following attributes:
 - **furtherDetails** – A **characterString** attribute which enables the user to add any further necessary detail regarding the **methodCode** and **methodClassificationCode**. In scenarios where the **methodClassificationCode** has been populated using the value 'OTH' referring to other measurement/calculation methodologies, this attribute should be populated further elaborating on the name and nature of this methodology.
 - **methodClassification** - Populated via the **MethodClassificationValue** code list. This in turn further classifies the method used to derive the quantity of the transfer. Article 5 of the E-PRTR requires that analytical method and/or the method of calculation shall be reported if the data is indicated as being based on measurement or calculation. Therefore, this attribute is required where the **methodCode** is reported as 'M' or 'C'. QAQC procedures will look to ensure this alignment is adhered to. Certain combinations are also not allowed. For example, if the **methodCode** is populated with the value 'M' referring to measured, the **methodClassificationCode** should refer to a measurement method classification such as 'WEIGH' (weighing), and not a classification which aligns with a different **methodCode**. The multiplicity for this attribute is [0..1], reflecting the fact this attribute is not required to be populated if the **methodCode** attribute is populated with 'E'.
 - **methodCode** – Populated via the **MethodCodeValue** code list. This code list in turn classifies the transfer in terms of whether the quantity was estimated, calculated or measured.
- **Pollutant** – Populated via the **EPRTRPollutantCodeValue** code list. This in turn refers to all pollutants listed in Annex II of the E-PRTR Regulation. It should be noted that this code list also includes PM_{2.5} and black carbon (BC), which are not pollutants within the E-PRTR Regulation, but is a key pollutant in the reporting to the CLRTAP (Convention on Long Range Transboundary Air Pollution). Users should treat this pollutant in a similar manner to those within Annex II of the E-PRTR Regulation, applying the same threshold as Particulate matter (PM₁₀) to guide as to whether to report this data. It should be noted however, that users are under no obligation to supply releases of PM_{2.5} even if the comparative threshold is exceeded and all reporting is therefore on a voluntary basis.
- **totalPollutantQuantityKg** – The total quantity of the pollutant released in the reporting year. Such a value should be reported as a positive real number in a double-precision floating-point format in terms units of **kilograms** and no other unit. This value should be inclusive of both accidental and routine releases into the same medium for the pollutant referred to in the pollutant attribute.

4 Preparing country reports: use of the IT tools

NOTE: This section is currently still under development and will be amended after completion of the IT tools.

4.1 Reporting data to the CDR: overall workflow

Reportnet is the European Environment Information and Observation Network's (Eionet) infrastructure for supporting data and information flows. The existing systems available within Reportnet will be utilised for the EU Registry and integrated E-PRTR and LCP thematic data reporting. This includes the Central Data Repository (CDR) of Reportnet, which contains built-in modules for automated data conversion, aggregation and QA/QC checks.

4.2 User accounts and permissions

Reporting to the E-PRTR+LCP Thematic Data Flow requires:

- An Eionet account with user name and password is required as well as specific permission to upload the national delivery.
- Having specific permissions to report, on behalf of your country, to the relevant obligation. The E-PRTR+LCP Thematic reporting is recorded at the Reporting Obligation Database (Obligation 720; <http://rod.eionet.europa.eu/obligations/720>)

Please liaise with Eionet Helpdesk (helpdesk@eionet.europa.eu) if you do not have an account. Permissions for the relevant obligation are assigned directly by the EEA Industrial Emissions team. Permissions for this dataflow are managed in a so-called Extranet list. The list of representatives that currently have permissions to report for a given country can be seen online at http://www.eionet.europa.eu/ldap-roles/?role_id=extranet-eprtrlcp-data . Please contact the EEA Industrial Emissions team in the event that this list is out of date (Industrial.Emissions@eea.europa.eu).

4.3 Reporting routes

Member states uploading submissions to the CDR may do so via two different reporting routes. These routes are illustrated in Figure 16 below.

- The XML route, consists of member states submitting a compliant XML to the CDR which has been directly generated from their national system. This system could consist of a variety of different platforms or softwares such as Microsoft Access databases.
- The access database route utilises an access template designed within the EEA, which is subsequently populated from a member states' national system. A conversion service created by the EEA, will, when uploaded to the online platform, transform the template into a compliant XML which can then be submitted to the CDR.

Figure 16 - Depiction of the XML and access database reporting routes

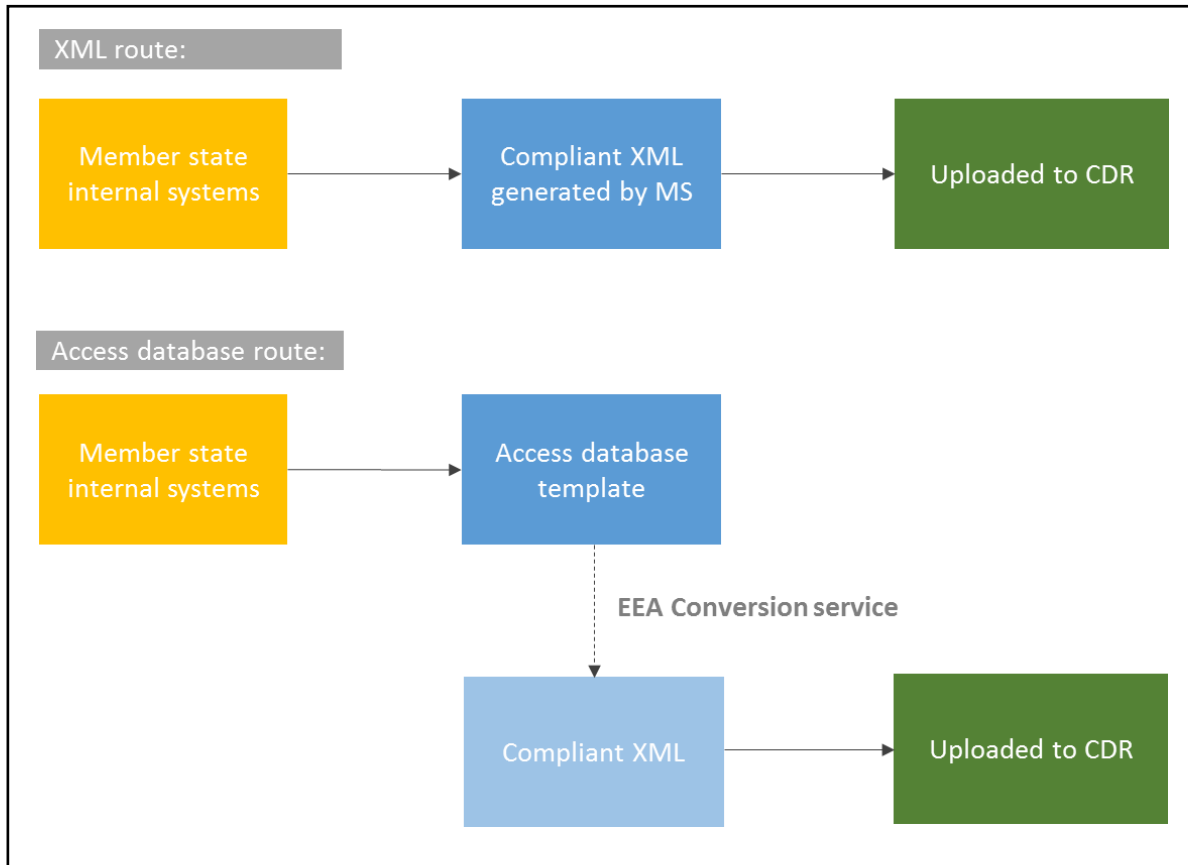

4.3.1 Using the XML Route: Preparation of a compliant XML file

Countries that choose to report by uploading a self-generated XML file need to consider:

- The syntax requirements and attribute's requirements set out in the XML Schema. XML schemas for this dataflow are stored at the EEA [Data Dictionary](#).
- For attributes dependent on code lists, properly use the Uniform Resource Identifiers (URIs) of the codes as stored in the EEA [data dictionary](#).

Once the XML file is uploaded at the CDR, an XML validation will ensure the file complies with the first two bullet points. A dedicated check also validates the use of accepted codes from the given code lists amongst other checks which are documented in the QA Logic Manual for E-PRTR & LCP Integrated Reporting, which is currently available on the [project website](#). These validations need to be passed without errors for the workflow to continue.

Note that these validation checks can be run by reporting countries at any time and not just at the point of release of the submitted files. If files are found to have errors, they can be replaced with revised uploads. It is only when the CDR 'envelope' is released that the file will be formally submitted to the EEA and will then proceed through further manual checking and data harvesting activities within the EEA.

4.3.2 Reporting using the Ms Access route: the template and the conversion service

As an alternative to reporting via self-generated XML, reporting countries can report via a Microsoft Access database template. This template will be designed by the EEA to enable population by thematic individuals, which subsequently can be converted to XML via the EEA's conversion service. Further guidance on how to populate the access template will be developed and will be accessible to thematic individuals within reporting countries. Reporting countries that wish to provide a submission via this route should consider the following:

- The Microsoft Access template cannot be changed (i.e. no extra tables or attributes can be added).
- For attributes dependent on code lists, properly use the Uniform Resource Identifiers (URIs) of the codes as stored in the EEA [data dictionary](#).

4.4 Login, creation of envelopes and upload of reports

Eionet users with permissions for the dataflow must log in the Central Data Repository at <http://cdr.eionet.europa.eu/>. The login button is located at the top right part of the screen.

Each country has a folder for the reporting obligation for thematic data where reports must be uploaded. The relevant folder can be access through the following routine:

1. Click in your country's name
2. Click in European Union (EU) obligations
3. Click in E-PRTR+LCP Thematic Reporting

Reports are to be uploaded in envelopes, according to CDR's terminology. For each reporting year a new envelope must be created. The button to create a new envelope appears in the top right of the screen once a user is logged in and has the appropriate reporting permissions. To upload files into the envelope the user will need to 'activate task' which can be done by clicking the respective button on the right hand of the screen, once a new envelope has been created.

4.5 Quality Assurance: validating your report

4.5.1 Scope and logic of the automated quality assurance

When a report (XML file) is uploaded to CDR, the system runs a series of checks to ensure:

- Its semantic and syntactic coherence with the XML Schema
- The use of valid code values according to code lists
- The consistency of the data with previous submissions and a set of logical rules.

A separate stand-alone document establishes the logic of the quality assurance mechanism and is available on the [project website](#). All checks run in CDR are developed according to its logic.

4.5.2 Validation feedback provided at CDR

The automated quality assurance checks are divided into two groups: XML Schema validation is run under QA #1 and the main QAQC checks are run under QA #2.

The semantic and syntactic coherence with the XML Schema can be seen by running QA #1. Errors with compliance in the file are highlighted individually.

The consistency of the report with regards to accepted code list values, previous submissions and a set of logical rules can be seen by running QA #2. Errors in the submission are grouped by check and the IDs for the entities that have flagged the check are listed.

The variable results the checks are colour coded:

- **Red** – Blocking error, this will prevent the release of the envelope.
- **Orange** – Warning error.
- **Blue** – Information message.
- **Green** – No errors.

More information about these checks and the criteria used can be found in 'Quality assurance logic - Document for users' (available on the [project website](#)) as well as in Annexes 4 and 5 of this document.

4.6 Official submission of the report

Submitting a report corresponds, in CDR, to the option 'Release envelope'. Aspects to consider when releasing envelopes:

- When the XML file is uploaded to the CDR, reporters will have the option to tick a 'restricted from public view' tick box. If the report contains any confidential information, reporters must click the 'restricted from public view' tick box to restrict public access to the XML on the CDR once it has been released. If ticked, the entire XML will be unavailable on the CDR for public viewing. The harvesting tool will then exclude data marked confidential from public products. If the 'restricted from public view' tick box is left unticked, then the full XML will be available for public viewing on the CDR. However, if a reporter forgets to tick this box, they can revisit the envelope, delete the file and then reload the file and tick the 'restricted from public view' tick box on the file upload screen.
- When the user clicks in the option "Release envelope", the system runs all QA/QC rules. If the mandatory aspects do not result in so-called "blocking errors" the system will allow the effective release of the envelope, otherwise, the workflow will go back to draft and the user will have to correct the blocking errors before releasing the envelope. In case of absence of blocking errors, the report is submitted and received by the EU.
- Once the user clicks 'Release envelope', after a few minutes, a confirmation of receipt message and automatic feedback is stored automatically in the envelope's feedback area. You may review the confirmation of receipt by clicking the corresponding link on the envelope and double check your envelope is in the status 'complete'.

A confirmation of receipt in the envelope means that your report is successfully submitted to the EEA however this does not mean that the quality of the submission is to the satisfaction of the EEA and/or European Commission. Therefore, the EEA or the European Commission may contact the reporter at a later stage to clarify the content or request a resubmission of the report if need be.

4.7 Processes that take place after the submission

The EEA run a harvesting procedure in order to integrate the data stored in each CDR envelope submitted into an internal centralised master database. The EEA will run a series of quality assurance processes on the data once the EU dataset is generated. The issues identified during this process are communicated bilaterally to the country reporters to obtain further feedback or corrections where needed. A series of 'public data products' will be generated from this internal database.

Annex 1 – Internationally approved measuring methods

In reporting ‘measured’ releases, the user is required to supply the name of the standard used in the ‘furtherDetails’ attribute of the ‘PollutantRelease’ feature type. The different steps of these measurement methods (sampling, transport and storage, pre-treatment, extraction, analysis-quantification, reporting) are standardised in one or several standards. For releases to air standards generally cover all steps of the measurement methods. For releases to water, the quoted standards generally cover the analysis/quantification procedure. A full list of ‘internationally approved measuring methods for air and water pollutants’ can be found within Appendix 3 of the 2006 E-PRTR Guidance Document. This list, however, will only be updated periodically, and often standards can be revised and therefore appear out of date. Users are therefore encouraged to access the following resources to determine the applicable standards:

- For all ISO standards: <https://www.iso.org/standards-catalogue/browse-by-ics.html>
- For all EN standards: <https://standards.cen.eu>

In general, the Competent Authority or other regulatory body within each reporting country would specify the standards which should be used for the measurement of emissions. The BAT Reference Document on the General Principles of Monitoring may also serve as a useful reference for reporters and should be used to ensure that representative measurement of emissions is carried out.

- http://eippcb.jrc.ec.europa.eu/reference/BREF/mon_bref_0703.pdf

Annex 2 – Indicative list of pollutants per E-PRTR activity

The following tables provide an indication of the anticipated pollutants to be reported at the E-PRTR facility level for each respective E-PRTR annex I activity. Note that the E-PRTR annex I activity is reported separately within the EU Registry, however pollutant releases to land, water and air are aspects considered within this data flow. The following tables have been developed within Tableau visualisation software using the releases reported to the EEA for reporting years 2007 to 2015. The strength of the colour from light to dark, indicate the number of releases of that pollutant /activity combination. It should be noted that the reporting under the E-PRTR for reporting years 2007-2015 is recognised to be incomplete for several pollutants, particularly in respect to releases to water and land. The tables below therefore form a rough guide only, based on the current state of reporting, and not a complete assessment.

Table A2 2 - Indicative sector specific sub-list of pollutants in releases to land.

EPRT annex I activity code	1,1,1-trichloroethane	1,2-dichloroethane	Anthracene	Arsenic and compounds)	Benzopyrene	Cadmium and compounds	Chlorides	Chromium and compounds	Copper and compounds	Dichloromethane	Diuron	Fluoranthene	Halogenated organic compounds	Hexabromobiphenyl	Lead and compounds	Mercury and compounds	Naphthalene	Nickel and compounds	Nonylphenol and Nonylphenol ethoxy..	Octylphenols and Octylphenol ethoxy..	Organotin compounds	PCDD + PCDF	Phenols	Polychlorinated biphenyls	Polycyclic aromatic hydrocarbons	Tetrachloroethylene	Toluene	Total nitrogen	Total organic carbon	Total phosphorus	Trichlorobenzenes	Vinyl chloride	Zinc and compounds	
1.(c)																																		
2.(b)																																		
2.(d)																																		
2.(e)																																		
2.(f)																																		
3.(a)																																		
4.(a)																																		
4.(b)																																		
4.(e)																																		
5.(a)																																		
5.(b)																																		
5.(c)																																		
5.(d)																																		
5.(f)																																		
5.(g)																																		
6.(a)																																		
6.(b)																																		
7.(a)																																		
8.(a)																																		
8.(b)																																		
8.(c)																																		
9.(c)																																		

For releases to land, only 33 pollutants were reported.

Annex 3 – Examples of reporting

This annex presents two examples of plausible reporting scenarios including both an E-PRTR facilities and LCP installation parts to demonstrate how the reporting of various thematic data operates in practice. To do this each example is accompanied by a description, describing the nature of the entities, and a set of data tables. These data tables are displayed in a format aligning to the Microsoft Access database template discussed in Section 4.3.2, and therefore represent data that could be submitted in a reporting context. It should be noted that identification and administrative data pertaining to E-PRTR facilities and LCP installation parts is reported under the EU Registry, and therefore attributes within this flow will not be detailed but may be touched upon where necessary.

Example 1: Example 1 consists of an LCP installation part within a larger E-PRTR facility. The LCP installation part is associated to the E-PRTR facility via the geographical hierarchy and the inspireIds reported in the EU Registry. Because of this alignment, certain QAQC checks included within the QAQC logic for this data flow, will ensure consistency between various comparable attributes. The LCP installation part is classified as an engine, burning only diesel and is not part of a larger refinery. The E-PRTR facility represents the larger entity in which two LCP installation parts are contained. The E-PRTR facility has no pollutant transfers for wastewater, or waste but does have releases to air and water that are required to be reported. The ProductionInstallationPartReport table within the template, which in turn represents the ProductionInstallationPartReport feature type, for the LCP installation part may look like below, the empty box for the 'withinRefinery' attribute represents a FALSE Boolean value:

ProductionInstallationPart_localId	ProductionInstallationPart_name	combustionPlantCategory	furtherDetails	numberOfOperatingHours	withinRefinery
000000001.PART	ES.CAED	http://dd.eionet.europa.eu/vocabulary/EPRTRandLCP/CombustionPlantCategoryValue/DieselEngine		5678	<input type="checkbox"/>

As the LCP installation part burns only diesel, the energy input of this diesel will need to be reported. As discussed in Section 3.3.3, despite the fact that only diesel is combusted within the LCP, reporting of other fuels is still required to affirmatively report that these fuels are not combusted. The EnergyInput table, which in turn represents the EnergyInput feature type, may look like so:

ProductionInstallationPart_localId	fuelinput	otherSolidFuel	otherGaseousFuel	furtherDetails	energyInputTJ
000000001.PART	http://dd.eionet.europa.eu/vocabulary/EPRTRandLCP/FuelInputValue/Coal				0
000000001.PART	http://dd.eionet.europa.eu/vocabulary/EPRTRandLCP/FuelInputValue/Biomass				0
000000001.PART	http://dd.eionet.europa.eu/vocabulary/EPRTRandLCP/FuelInputValue/Lignite				0

ProductionInstallationPart_localId	fuelinput	otherSolidFuel	otherGaseousFuel	furtherDetails	energyInputTJ
000000001.PART	http://dd.eionet.europa.eu/vocabulary/EPTRRandLCP/FuelInputValue/LiquidFuels				9000
000000001.PART	http://dd.eionet.europa.eu/vocabulary/EPTRRandLCP/FuelInputValue/NaturalGas				0
000000001.PART	http://dd.eionet.europa.eu/vocabulary/EPTRRandLCP/FuelInputValue/OtherGases				0
000000001.PART	http://dd.eionet.europa.eu/vocabulary/EPTRRandLCP/FuelInputValue/OtherSolidFuels				0
000000001.PART	http://dd.eionet.europa.eu/vocabulary/EPTRRandLCP/FuelInputValue/Peat				0

The LCP installation part will have resulted in emissions, as indicated by the energy input and number of operating hours. These emissions are reported according to the EmissionsToAir table, which represents the feature type of the same name. This table will need to be reported in accordance with the three pollutants stated in Article 72 of the IED. This table, when populated, may look like so:

ProductionInstallationPart_localId	pollutant	totalPollutantQuantityTNE
000000001.PART	http://dd.eionet.europa.eu/vocabulary/EPTRRandLCP/LCPPollutantCodeValue/Nox	2000
000000001.PART	http://dd.eionet.europa.eu/vocabulary/EPTRRandLCP/LCPPollutantCodeValue/SO2	500
000000001.PART	http://dd.eionet.europa.eu/vocabulary/EPTRRandLCP/LCPPollutantCodeValue/TSP	70

The E-PRTR facility contains the LCP installation part and, within the specific reporting year, employs 54 staff. The E-PRTR facility has two stacks, 20 and 60 metres in height respectively. The average height of the stacks can voluntarily be reported with the integrated CLRTRAP point source reporting discussed in Section 2.3. The ProductionFacilityReport table, which represents the feature type of the same name, may look like the below. Note that the number of operating hours is greater than that of the LCP installation part.

ProductionFacility_localId	ProductionFacility_namespace	numberOfOperatingHours	numberOfEmployees	remarks	representativeStackHeightM
000000001.FACILITY	ES.CAED	6280	54		40

The E-PRTR facility has multiple releases to water and air above the E-PRTR annex II thresholds. For releases to air, the pollutants above the annex II threshold are nitrogen oxide (NO_x), sulphur oxide (SO_x) and particulate matter (PM₁₀). For releases to water, zinc is above the annex II threshold and is required to be reported. This release was accidental, due to a technical issue. Releases to air were measured, whereas the release to water was estimated due to its unintentional nature. Note that for the releases to air, the quantity

for NO_x aligns with the value reported for the LCP installation part. Similar alignment exists for both; PM₁₀ and total suspended particles (TSP) and sulphur dioxide (SO₂) and SO_x. In each case the value reported at the facility is not less than the quantity reported at the LCP installation part. The PollutantRelease table, representing the feature type of the same name, under this scenario may look like this:

ProductionFacility_localId	pollutant	mediumCode	totalPollutantQuantityKg	AccidentalPollutantQuantityKG	methodCode	methodClassification
000000001.FACILITY	http://dd.eionet.europa.eu/vocabulary/EPTRandLCP/EPTRPollutantCodeValue/NOX	http://dd.eionet.europa.eu/vocabulary/EPTRandLCP/MediumCodeValue/AIR	200000	0	http://dd.eionet.europa.eu/vocabulary/EPTRandLCP/MethodCodeValue/M	http://dd.eionet.europa.eu/vocabulary/EPTRandLCP/MethodClassificationValue/CEN-ISO
000000001.FACILITY	http://dd.eionet.europa.eu/vocabulary/EPTRandLCP/EPTRPollutantCodeValue/PM10	http://dd.eionet.europa.eu/vocabulary/EPTRandLCP/MediumCodeValue/AIR	60789	0	http://dd.eionet.europa.eu/vocabulary/EPTRandLCP/MethodCodeValue/M	http://dd.eionet.europa.eu/vocabulary/EPTRandLCP/MethodClassificationValue/CEN-ISO
000000001.FACILITY	http://dd.eionet.europa.eu/vocabulary/EPTRandLCP/EPTRPollutantCodeValue/SOX	http://dd.eionet.europa.eu/vocabulary/EPTRandLCP/MediumCodeValue/AIR	500678	0	http://dd.eionet.europa.eu/vocabulary/EPTRandLCP/MethodCodeValue/M	http://dd.eionet.europa.eu/vocabulary/EPTRandLCP/MethodClassificationValue/CEN-ISO
000000001.FACILITY	http://dd.eionet.europa.eu/vocabulary/EPTRandLCP/EPTRPollutantCodeValue/ZN%20AND%20COMPOUNDS	http://dd.eionet.europa.eu/vocabulary/EPTRandLCP/MediumCodeValue/WATER	471	471	http://dd.eionet.europa.eu/vocabulary/EPTRandLCP/MethodCodeValue/E	http://dd.eionet.europa.eu/vocabulary/EPTRandLCP/MethodClassificationValue/CEN-ISO

Example 2: Example 2 consists of an E-PRTR facility reporting the transfer of hazardous waste and non-hazardous waste within country and across county borders. The E-PRTR facility has no associated LCP installation parts, employs 35 people and no stack to report. The ProductionFacilityReport table would look like below:

ProductionFacility_localId	ProductionFacility_namespace	numberOfOperatingHours	numberOfEmployees	remarks	representativeStackHeightM
000000002.FACILITY	IT.CAED	4500	35		

The relevant authority has chosen to report the production volume of the E-PRTR facility, the product is basic inorganic chemicals, of which, the E-PRTR facility produces 3000 tonnes per year. In this case, the ProductionVolumeType table would look like below:

ProductionVolumeTypeId	ProductionFacility_localId	productName	productionVolume	productionVolumeUnits
1	000000002.FACILITY	BASIC INORGANIC CHEMICALS	3000	http://dd.eionet.europa.eu/vocabulary/EPTRandLCP/UnitCodeValue/TNE

The E-PRTR facility has no pollutant transfers for wastewater, nor pollutant releases above the Annex II thresholds but does have offsite waste transfers to report. Hazardous waste (HW) and non-hazardous waste (NONHW) is transferred from the E-PRTR facility both within the borders of the host country and across into a different country. The HW and NONHW transferred across the country borders is destined for recovery and the quantities have been measured by weighing the amount of waste. The HW and NONHW transferred

within the country borders is destined for disposal and the quantities have been estimated, so no method classification is required. The address details of the receiver and receiving site for the waste is only required for the HW that has been transferred across the country border. In this case, the OffsiteWasteTransfer table would look like below. For formatting purposes, a single line in the Access table has been split into two lines (Receiver_buildingNumber follows Receiver_streetName) and the confidentiality reason attribute has been omitted.

Offsite WasteTransferId	ProductionFacility_localId	wasteClassification	wasteTreatment	totalWasteQuantityTNE	methodCode	methodClassification	furtherDetails	nameOfReceiver	Receiver_streetName
1	000000002.FACILITY	http://dd.eionet.europa.eu/vocabulary/EPTRandLCP/WasteClassificationValue/HW	http://dd.eionet.europa.eu/vocabulary/EPTRandLCP/WasteTreatmentValue/R	300	http://dd.eionet.europa.eu/vocabulary/EPTRandLCP/MethodCodeValue/M	http://dd.eionet.europa.eu/vocabulary/EPTRandLCP/MethodClassificationValue/WEIGH		SUNSHINE WASTE RECOVERY COMPANY	SUN STREET
2	000000002.FACILITY	http://dd.eionet.europa.eu/vocabulary/EPTRandLCP/WasteClassificationValue/NONHW	http://dd.eionet.europa.eu/vocabulary/EPTRandLCP/WasteTreatmentValue/R	2500	http://dd.eionet.europa.eu/vocabulary/EPTRandLCP/MethodCodeValue/M	http://dd.eionet.europa.eu/vocabulary/EPTRandLCP/MethodClassificationValue/WEIGH			
3	000000002.FACILITY	http://dd.eionet.europa.eu/vocabulary/EPTRandLCP/WasteClassificationValue/HW	http://dd.eionet.europa.eu/vocabulary/EPTRandLCP/WasteTreatmentValue/D	50	http://dd.eionet.europa.eu/vocabulary/EPTRandLCP/MethodCodeValue/E				
4	000000002.FACILITY	http://dd.eionet.europa.eu/vocabulary/EPTRandLCP/WasteClassificationValue/NONHW	http://dd.eionet.europa.eu/vocabulary/EPTRandLCP/WasteTreatmentValue/D	5000	http://dd.eionet.europa.eu/vocabulary/EPTRandLCP/MethodCodeValue/E				
Receiver_buildingNumber	Receiver_city	Receiver_postalCode	Receiver_country	nameOfReceivingSite	ReceivingSite_streetName	ReceivingSite_buildingNumber	ReceivingSite_city	ReceivingSite_postalCode	ReceivingSite_countryCode
5	JACKSONTOWN	ABC 123	UK	SUNSHINE WASTE RECOVERY PLANT	SUN STREET	5	JACKSONTOWN	ABC 123	UK

Annex 4 – Glossary of Terms

This section contains explanations of the key terms used in this document.

Boolean attribute – These attributes are evaluated as either true or false.

Code list – a defined set of values which can be used to populate an attribute.

Data type – A data model element which defines characteristics of data and which operations can be performed on the data.

Feature type – Represents a class of data together with relevant attributes.

Geospatial information – Data about a physical object that can be represented by numeric values in a geographic coordinate system.

INSPIRE – Infrastructure for Spatial Information in the European Community. The INSPIRE Directive (2007/2/EC) aims to establish an infrastructure for the sharing of environmental spatial data within the European Union. This will enable sharing among public sector organisations, facilitate public access to spatial data across Europe, and will aid in cross-boundary policy making.

LocalId – Second component of the INSPIRE identifier, containing a unique identifier referring to the entity reported.

Multiplicity – A definition of cardinality - i.e. the permitted number of elements - of some collection of elements.

Namespace – First component of the INSPIRE identifier. This normally contains a reference to the country submitting the data as well as the authority responsible for the submission.

Production Facility – One or more installations on the same site that are operated by the same natural or legal person. A Production Facility is a special kind of Activity Complex.

Production Installation Part – Represents a specific technical part of the installation, developing a representative functionality that should be registered under the legislation.

UML – Unified Modelling Language, a modelling language intended to provide a standard way to visualise the design of a system.

XML – EXtensible Markup Language is a markup language that defines a set of rules for encoding documents. This format is readable by both humans and machines.

Annex 5 – Mapping between previous data structures and new structure

Both the E-PRTR and the IED have reporting formats that were previously established to collect the necessary data from reporting countries. This annex is focused on attempting to map the various aspects of previous reporting formats to the E-PRTR+LCP data model presented in this document. The table below contains all attributes listed in the new E-PRTR+LCP data model alongside the aspect or field of the previous reporting format.

E-PRTR+LCP data model attribute	Previous LCP reporting format	Previous E-PRTR reporting format
CountryId	Replaces the 'Member State' field.	Replaces the 'CountryID' element.
reportingYear	Replaces the 'Reference Year' field.	Replaces the 'Reporting Year' element.
inspireId	Replaces the 'Plant ID' field.	Replaces the 'NationalID' and 'PreviousNationalID' elements (as the inspireID is required to stay constant throughout the lifetime of the facility reported).
numberOfOperatingHours	Replaces the 'Operating Hours' field.	Replaces the 'OperationHours' element.
CombustionPlantCategory	Replaces the 'Gas turbine', 'Gas engine', 'Boiler', 'Diesel Engine' and 'Other' Boolean fields.	N/A
WithinRefinery	Replaces the 'Refineries' Boolean field.	N/A
ConfidentialityReason	N/A	Replaces the 'ConfidentialCode' element.
DesulphurisationInformation	Replaces the 'Desulphurisation rate (%)' and 'S Input (t)' fields	N/A
energyInputTJ	When combined, these attributes replace the 'Biomass (TJ)', 'Other Solid fuels (TJ)', 'Liquid fuels (TJ)', 'Natural gas (TJ)', and 'Other gases (TJ)' fields.	N/A
fuelInput		N/A

E-PRTR+LCP data model attribute	Previous LCP reporting format	Previous E-PRTR reporting format
totalPollutantQuantityTNE	When combined, these attributes replace the 'SO2 (t)', 'NOx (t)' and 'Dust (t)' fields.	N/A
LCPPollutantCodeValue		N/A
numberOfEmployees	N/A	Replaces the 'TotalEmployeeQuantity' element.
productionVolume	N/A	Replaces the 'ProductionVolume' element
wasteClassification	N/A	Replaces the 'WasteTypeCode' element.
wasteTreatment	N/A	Replaces the 'WasteTreatmentCode' elements.
method	N/A	Replaces both the 'MethodBasisCode' and 'MethodUsed' elements, via linkage to MethodType data type.
transboundaryTransfer	N/A	Replaces the 'WasteHandlerParty' element.
totalWasteQuantityTNE	N/A	Replaces the 'Quantity' element, in the WasteTransfer elements.
totalPollutantquantityKg	N/A	Replaces the 'Total Quantity' in the PollutantRelease elements.
EPRTRPollutantCodeValue	N/A	Replaces the 'PollutantCode' element.
accidentalPollutantQuantityKg	N/A	Replaces the 'AccidentalQuantity' element.
mediumCode	N/A	Replaces the 'MediumCode' element.